



LET'S BECOME
OUR INSPIRATION...

THE FOLLOWING
PAGES SHOW
OUR MOST SOLD
PRODUCTS
AND SOMETHING
MORE...

READ
AND
CHOOSE...

CZECH
MANUFACTURER
WWW.KLARO.CZ



You can take our consulting services for granted. We will advise you and propose the most suitable solution, including the graphic design... right at your facility.



WE ARE
HERE
FOR YOU



Haven't you heard of our products yet? So please, get to know them as soon as you can...

If you know us already, please select from our new products and use them to complete and expand the equipment of your operations.



We know how to fit our offer to your space and to your financial possibilities.



Klaroboy will
always help you!

We will deliver your ordered products, and we will also train your personnel on site FOR FREE.

OUR COMPANY 5

SPECIFICATION OF PRODUCT LINES AND MATERIALS 6

ABOUT THE MODULE SYSTEM 8 - 10

MODULE SYSTEM - MULTIFUNCTIONAL CABINETS AND CARTS

CABINETS - METAL LINE BASIC 11

METAL LINE PROFI 12

METAL LINE ECO 13

CARTS - UNI-TRANS MINI 14

UNI-STRANS STANDARD 15

MODULE SYSTEM - MULTIFUNCTIONAL CARTS

METAL LINE BASIC 18 - 37

METAL LINE PROFI 39 - 57

EXAMPLES OF CART ASSEMBLIES 59 - 61

MULTIFUNCTIONAL CARTS WITHOUT MODULE SYSTEM

METAL LINE ECO 63 - 78

EXAMPLES OF CART ASSEMBLIES 79 - 80

COMPLEMENTS TO MULTIFUNCTIONAL CARTS

DESKTOPS 81

ACCESSORIES TO BASIC, PROFI, ECO 82 - 85

STEEL DRAWERS AND WITH MS BASKETS 86 - 87

DIVISION OF MS BASKETS USING DIVIDERS 88 - 89

ALL DIMENSIONS IN THE CATALOGUE ARE IN CM.
ALL IMAGES ARE ILLUSTRATIVE ONLY.

CONTENTS

STAINLESS STEEL PLATES WITH MODULE SYSTEM

L-LINE - WITH MODULE SYSTEM	91 - 93
L-LINE - ALL-STAINLESS WITHOUT MODULE SYSTEM	94 - 95
ACCESSORIES	96

ALL-STAINLESS STEEL PLATES WITHOUT DRAWERS

L-LINE	97
M-LINE	98
XL-LINE	99 - 100
XXL-LINE	101

HEALTHCARE FURNITURE

INSTRUMENTATION CARTS	102 - 109
FOR INFECTIOUS WASTE	110
INFUSION STANDS AND HOLDERS	111
MOBILE STAINLESS STEEL STANDS	112 - 113
HANGING RACK SYSTEM AND STEPS	114
STAINLESS STEEL STANDS, HOLDERS FOR MASKS, X-RAY APRONS	115
INFANT CART	115

ATYPICAL PRODUCTION

CABINETS	116
DESKS	117
MOBILE CABINETS AND RACKS FOR SU _s /STE CONTAINERS	117
CARTS FOR TRAYS AND TABLETS	118
INSTRUMENT CARTS	118
SHELVES AND WALL HOLDERS	119
RACKS	119

CONTACT	122
----------------	------------

NOTES	123
--------------	------------

ALL DIMENSIONS IN THE CATALOGUE ARE IN CM.
ALL IMAGES ARE ILLUSTRATIVE ONLY.

You have just received a new product catalogue of **KLARO, s r. o.** company for the healthcare sector.

The entirely Czech company KLARO, s r. o., founded in 1990, manufactures handling equipment. Our product range is being continuously expanded, and our products are becoming more and more sophisticated. During the last years, we managed to assemble a well coordinated team of professionals from different fields and to build our own, technically advanced facility at Velké Chvalovice, where we have concentrated all our production.

We can be proud of our most comprehensive offer of handling equipment on the Czech market. Our offer is tailored for sophisticated healthcare facilities, social services, accommodation and other facilities. Our products simplify the work and help increase the quality for our customers at many places in the Czech Republic and abroad.

Our customers can choose from a huge number of types of carts and accessories of a different design, sizes and a wide range of colours.

We monitor new trends, flexibly respond to more and more demanding requirements on quality, and we are continuously developing and proposing new improvements and new types of carts. We don't leave any idea unnoticed. We collect new findings and experiences from different types of facilities, and we use them to improve and design our products. Our development never ends.

Let's become our inspiration...

Here we have tried to create an easy to understand outline of our most used products so that you can navigate through the new catalogue easily. Please, make your own judgement whether our effort was successful.

The following pages offer a small sample. Please read and choose...



ČSN EN ISO
9001:2009



ČSN EN ISO
14001:2005



Our products are designed to:

- minimize your effort
- make your work more effective
- save your energy
- shorten the time of handling materials
- make the arrangement and storage of material, tools, documentation, etc. more organized
- allow better control, durability against the wear and easy maintenance
- have a good look and keep their high functionality
- have every detail made of the most quality materials
- have universal complements, parts and accessories usable for different types of carts

SPECIFICATION OF PRODUCT LINES AND MATERIALS

The largest area we target is the healthcare. We deliver multi-purpose carts, cabinets, etc. Such products are sorted into three categories: **ECO, BASIC AND PROFI.**

To make your decision among these variants easier, **there are several important differences.**

BASIC line

- most favourite variant, including an unlimited selection of complements
- equipped with MODULE SYSTEM
- suitable for all facilities
- dust-tight drawers

PROFI line

- best quality, made of top materials
- cart construction - stainless steel AISI304
- equipped with MODULE SYSTEM
- suitable for all operations, including the most demanding
- dust-tight drawers

ECO line

- affordability while maintaining the quality and functionality of carts
- cart construction including drawers - steel
- limited choice of complements
- suitable for all operations

Specification of used stainless steel in our production:

We offer stainless steel parts and products in two versions.

Stainless steel AISI304 - STANDARD MATERIAL

- standardly used material for our products
- use in regular food or medical facilities
- resistant to common cleaning agents

Stainless steel AISI316L - SPECIAL MATERIAL

- extraordinary use of the material upon customer's request
- use for storage or handling of chemicals
- resistant to conventional cleaning agents as well as chloride acids and compounds.



MULTIFUNCTIONAL CABINETS - MODULE SYSTEM

For our products, we use all the benefits of the module system. All types of module baskets can be hung in our open, closed, drawer or shutter carts. The inner sides of carts are equipped with hinges so that it is possible to hang on them differently deep baskets and to combine them according to topical need. The baskets can also be supplemented with dividers and a plastic case for labels - easily placed in different positions.

MODUL SYSTEM



MULTIFUNCTIONAL CABINETS - MODULE SYSTEM

Simplicity, organized, variable and intelligent system of supplies managements. Functionality and technology in the perfect harmony.

At customer's request, we can assemble entire room furnishings. In addition to mobile products, we also offer fixed products, such as different types of racks, cabinets, stainless steel desks, countertops, sinks, shelves and other accessories. In the areas, where material transferred in MS baskets is collected, we supply lockable dust-tight cabinets in three different heights with full or glassed doors. In addition to enclosed cabinets, the material in MS baskets can also be stored in open shelves of various sizes. Both types, open and closed, are equipped with rails for hanging differently deep MS baskets. The full fronts of cabinets, small cabinets, shelves, etc. are supplied in different colours. Therefore, the whole room can be colour matched according to your wishes.



MODULE SYSTEM offers optimum storage solutions.

The multifunctional carts of the module system line are an efficient solution to logistical problems with the material. The customer chooses his own equipment, a combination of drawer units and individual cart accessories such as baskets, drawers, tubs, dividers, etc.

PLASTIC BASKETS - MS SYSTEM

You will discover their simplicity and organization based on space utilization and efficient control of supplies. They are made of high-quality and durable ABS plastic. They are easy to maintain, hygienic, highly durable, withstand high temperatures and standard cleaning agents. Universal, shallow, medium and deep baskets can be placed in any way to all carts of the MODULE SYSTEM line.



Don't you know how to select? We will be happy to advise you! Toll free: +420 800 100 798

MULTIFUNCTIONAL CABINETS - MODULE SYSTEM

DIVIDERS (PARTITIONS)

Dividers have the shape of a „comb“, so they can be assembled freely into each other, thereby creating different sizes of the compartment - all the space is thus utilized. Changing the size of the compartments along the length and width and attaching them to the selected position can be done within a few seconds.



FLEXIBLE SYSTEM for easy handling the MS baskets



HORIZONTAL POSITION OF BASKETS

Possibility to pull out module baskets in the horizontal position in low and medium cabinet versions.

POSITION WITH THE BASKET ANGLE OF 25° OF MS BASKETS

Possibility to pull out module baskets at the 25° angle in the high cabinet version at the upper third part (first 12 positions).

Universal shallow, medium and deep baskets can be placed in any way to all carts/cabinets of MODULE SYSTEM.

LABELS

MS baskets may have labels attached.



Don't you know how to select? We will be happy to advise you! Toll free: +420 800 100 798

MULTIFUNCTIONAL CABINETS - MODULE SYSTEM

HEALTHCARE CABINETS - METAL LINE BASIC

- steel construction with powder coating, body colour RAL7042 - grey
- options of door colours according to samples
- the interior of the cabinet is fitted with plastic walls allowing the MS baskets to be suspended in three sizes (S, M, L)
- at the upper one third of the cabinet (first 12 positions) of the high version are side walls allowing tilting the MS basket out at the 25° angle to provide clear look inside; other side walls allow horizontal pulling the MS basket out
- cabinets are provided in two designs - with transparent or in a more affordable design - with full doors
- doors: lockable and dust-tight with the option of the left or right opening
- baskets are to be ordered separately

			RAL2011	RAL1011	RAL4008	RAL9005
RAL7042	RAL6018	RAL3020	RAL1021	RAL5015	RAL3015	RAL9003

LOW VERSION:

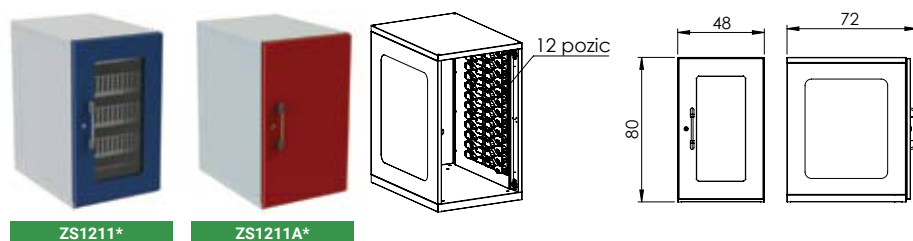

MS basket S size (cat. No. 11419)
- occupies 2 positions total

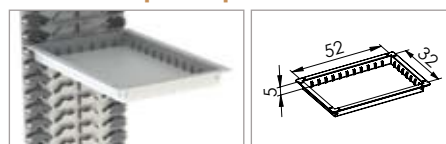

max. number of baskets in a single cabinet:
low version: 6 baskets (cabinet: 12 positions)
middle version: 12 baskets (cabinet: 25 positions)
high version: 19 baskets (cabinet: 38 positions)

MIDDLE VERSION:

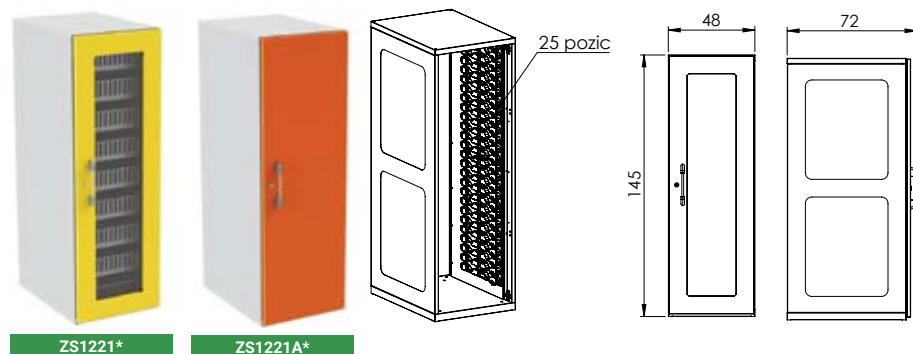

MS basket M size (cat. No. 11420)
- occupies 3 positions total

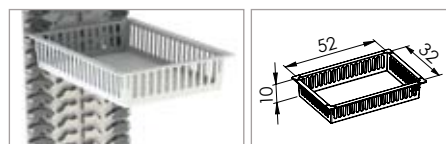

max. number of baskets in a single cabinet:
low version: 4 baskets (cabinet: 12 positions)
middle version: 8 baskets (cabinet: 25 positions)
high version: 12 baskets (cabinet: 38 positions)

HIGH VERSION:

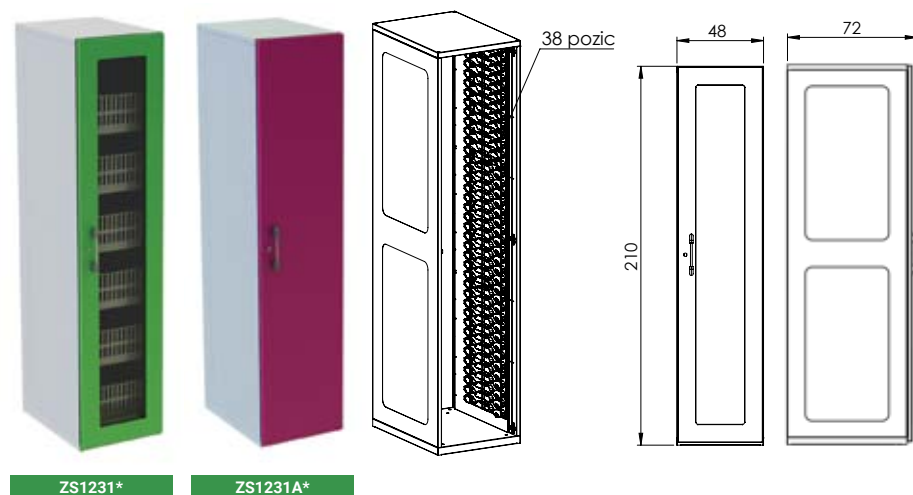

MS basket L size (cat. No. 11421)
- occupies 5 positions total

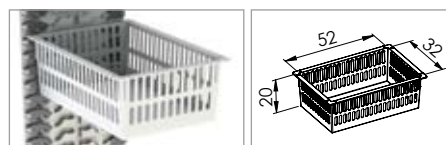

max. number of baskets in a single cabinet:
low version: 2 baskets (cabinet: 12 positions)
middle version: 4 baskets (cabinet: 25 positions)
high version: 7 baskets (cabinet: 38 positions)

Individual basket sizes can be arbitrarily combined with respect to the maximum number of positions.

Don't you know how to select? We will be happy to advise you! Toll free: +420 800 100 798

MULTIFUNCTIONAL CABINETS - MODULE SYSTEM

HEALTHCARE CABINETS - METAL LINE PROFI

- cabinet construction including the door - stainless steel AISI304
- the interior of the cabinet is fitted with plastic side walls allowing the MS baskets to be suspended in three sizes (S, M, L)
- at the upper third of the cabinet (first 12 positions) of the high version there are sidewalls allowing tilting the MS basket out at the 25° angle to provide clear look inside; other sidewalls allow horizontal pulling of the MS basket out
- cabinets are provided in two designs - with transparent doors or in more affordable design - with full doors
- doors: lockable and dust-tight with the option of the left or right opening
- baskets are to be ordered separately

LOW VERSION:

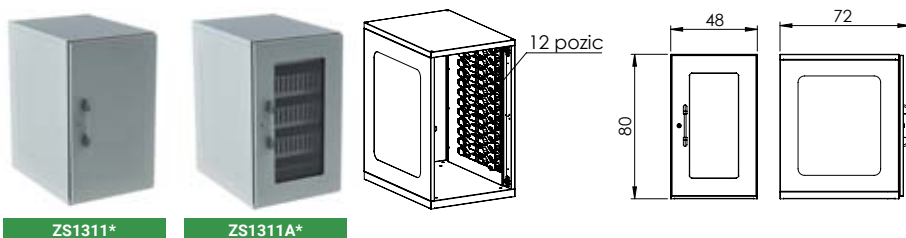

MS basket S size (cat. No. 11419)
- occupies 2 positions total



max. number of baskets in a single cabinet:
low version: 6 baskets (cabinet: 12 positions)
middle version: 12 baskets (cabinet: 25 positions)
high version: 19 baskets (cabinet: 38 positions)

MIDDLE VERSION:

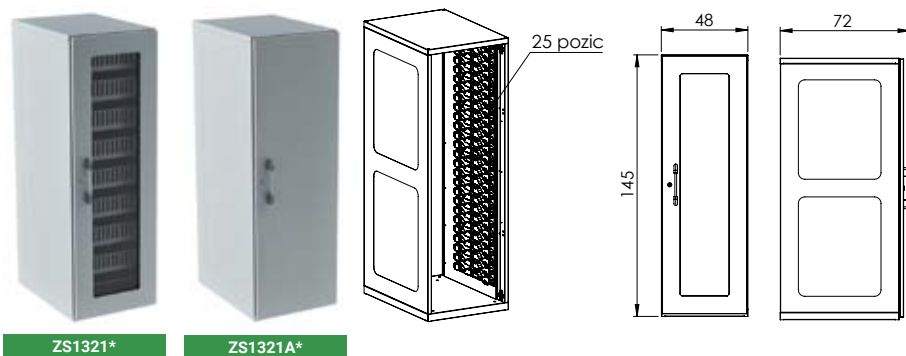

MS basket M size (cat. No. 11420)
- occupies 3 positions total

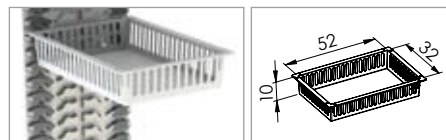

max. number of baskets in a single cabinet:
low version: 4 baskets (cabinet: 12 positions)
middle version: 8 baskets (cabinet: 25 positions)
high version: 12 baskets (cabinet: 38 positions)

HIGH VERSION:

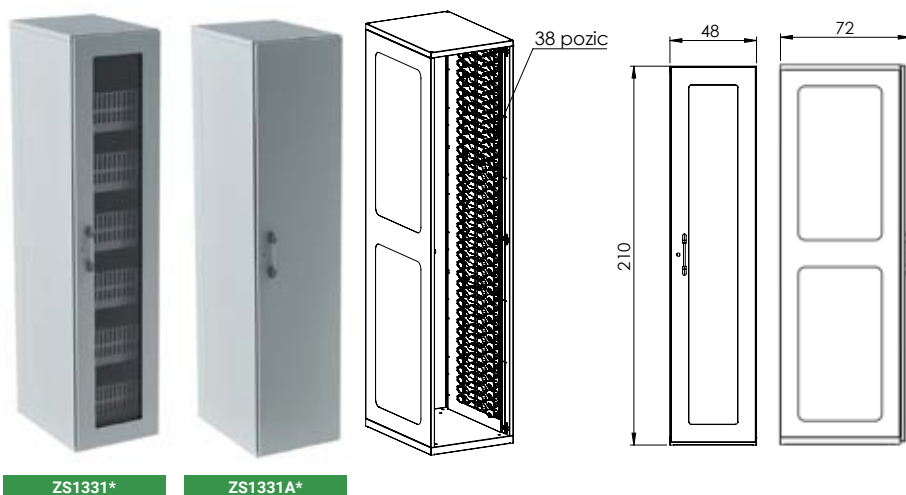

MS basket L size (cat. No. 11421)
- occupies 5 positions total

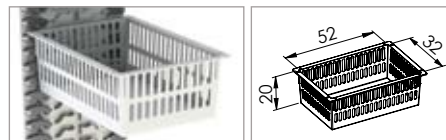

max. number of baskets in a single cabinet:
low version: 2 baskets (cabinet: 12 positions)
middle version: 4 baskets (cabinet: 25 positions)
high version: 7 baskets (cabinet: 38 positions)

Individual basket sizes can be arbitrarily combined with respect to the maximum number of positions.

Don't you know how to select? We will be happy to advise you! Toll free: +420 800 100 798

MULTIFUNCTIONAL CABINETS - MODULE SYSTEM

HEALTHCARE CABINETS - METAL LINE ECO

- steel cabinet construction including the door with powder coating RAL7042 - grey
- cabinet has mounting openings of 5 cm spacing for ledges and baskets
- at the upper one third of the cabinet (first 12 positions) of the high version, we recommend angled ledges (cat. No. 11426VAR01) with the option of tilting out to provide insight; other ledges are recommended to be horizontal (cat. No. 11427VAR01)
- cabinets are provided in two designs - with transparent doors or in more affordable design - with full doors
- doors: lockable and dust-tight with the option of the left or right opening
- baskets are to be ordered separately



Angled ledge
1 pair = 1 basket of all sizes (60 cm length)
cat. No. 11426VAR01



Horizontal ledge
1 pair = 1 basket of all sizes (60 cm length)
cat. No. 11427VAR01

LOW VERSION:



ZS1111*



ZS1111A*

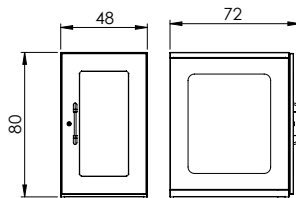
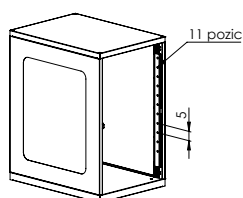

MS basket S size (cat. No. 11419)
- occupies 2 positions total

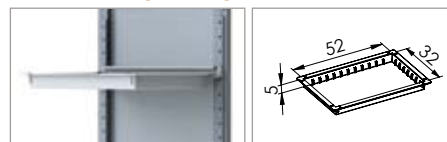

max. number of baskets in a single cabinet:
low version: 5 baskets (cabinet: 11 positions)
middle version: 12 baskets (cabinet: 24 positions)
high version: 17 baskets (cabinet: 35 positions)

MIDDLE VERSION:



ZS1121*



ZS1121A*

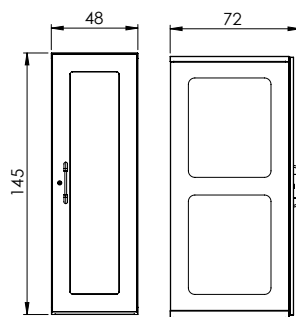
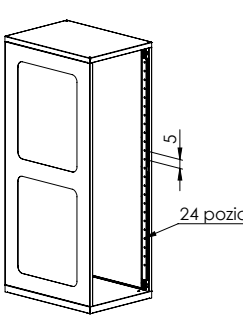

MS basket M size (cat. No. 11420)
- occupies 3 positions total

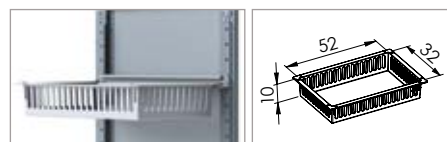

max. number of baskets in a single cabinet:
low version: 3 baskets (cabinet: 11 positions)
middle version: 8 baskets (cabinet: 24 positions)
high version: 11 baskets (cabinet: 35 positions)

HIGH VERSION:



ZS1131*



ZS1131A*

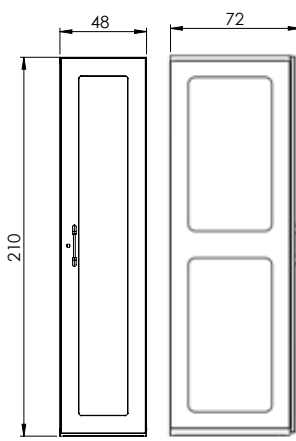
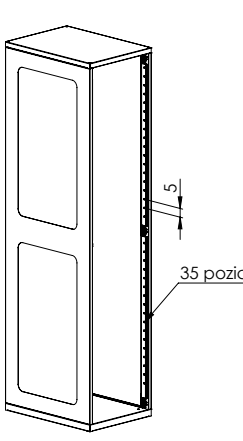

MS basket L size (cat. No. 11421)
- occupies 5 positions total

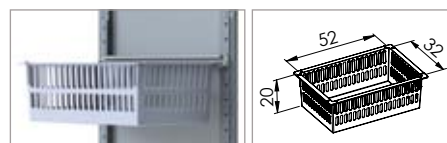

max. number of baskets in a single cabinet:
low version: 2 baskets (cabinet: 11 positions)
middle version: 4 baskets (cabinet: 24 positions)
high version: 7 baskets (cabinet: 35 positions)

Individual basket sizes can be arbitrarily combined with respect to the maximum number of positions

Don't you know how to select? We will be happy to advise you! Toll free: +420 800 100 798

MULTIFUNCTIONAL CABINETS - MODULE SYSTEM

HEALTHCARE CARTS - UNI-TRANS MINI

The picture is only illustrative, baskets have to be ordered separately.



2 types of basket sizes: STANDARD and MINI.
Baskets are to be ordered separately.

Plastic ledges to insert MS basket.

4x corner bumper made of resistant (PE) plastic.

STANDARD - 4x plastic caster Ø 12,5 cm, 2x brake
MINI - 4x plastic caster Ø 7,5 cm, 2x brake

Handles, made of stainless steel AISI304, inserted to plastic clips.

Cart construction including the desktop - stainless steel AISI304.

Baskets are pulled out to horizontal position.

Number of baskets depends on number of ledges (shallow, medium and deep.)
Positions of ledges are fixed and they are parts of cart.

Space between ledges: 15 cm.

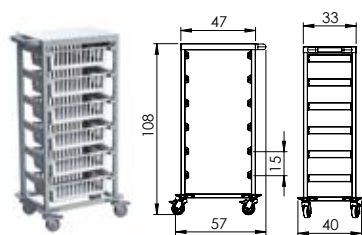

NEREZ5205*

basket size 3/4 - 6 positions

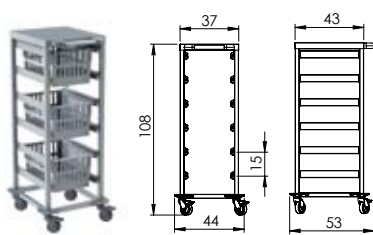

NEREZ5215*

basket size 3/4 - 6 positions

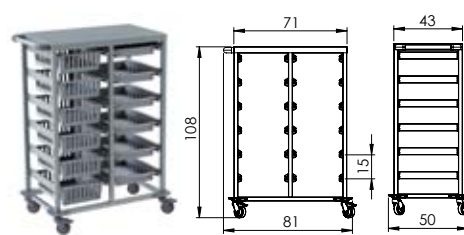

NEREZ5215*

basket size 3/4 - 12 positions

MS basket S size (cat. No. 11416)
- occupies 1 position total (1 pair)



MS basket M size (cat. No. 11417)
- occupies 1 position in total (1 pair)



MS basket L size (cat. No. 11418)
- occupies 2 positions total (2 pairs)



The individual basket sizes can be arbitrarily combined (with respect to the maximum number of positions).



Horizontal ledge
1 pair = 1 basket of all sizes (30 cm length)
cat. No. 11427VAR03



Horizontal ledge
1 pair = 1 basket of all sizes (40 cm length)
cat. No. 11427VAR02

Don't you know how to select? We will be happy to advise you! Toll free: +420 800 100 798

MULTIFUNCTIONAL CABINETS - MODULE SYSTEM

HEALTHCARE CARTS - UNI-TRANS STANDARD

The picture is only illustrative, baskets have to be ordered separately.

MODULE SYSTEM

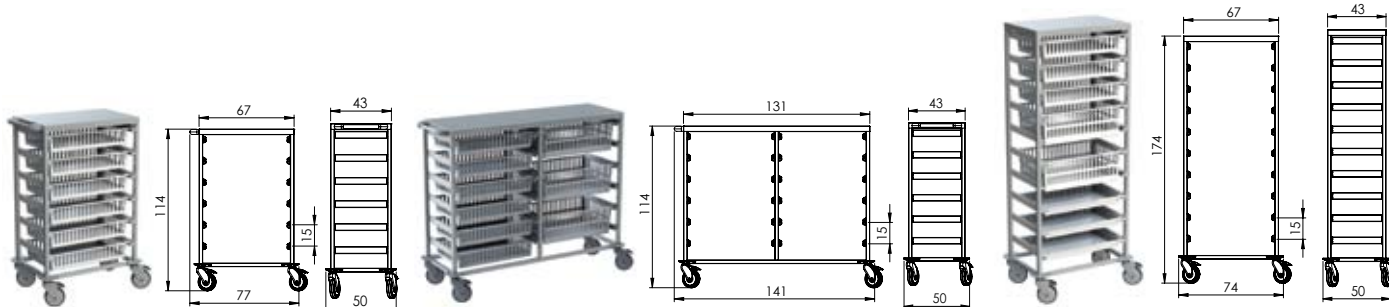

NEREZ5201*

basket standard size - 6 positions

NEREZ5202*

basket standard size - 12 positions

NEREZ5203*

basket standard size - 10 positions

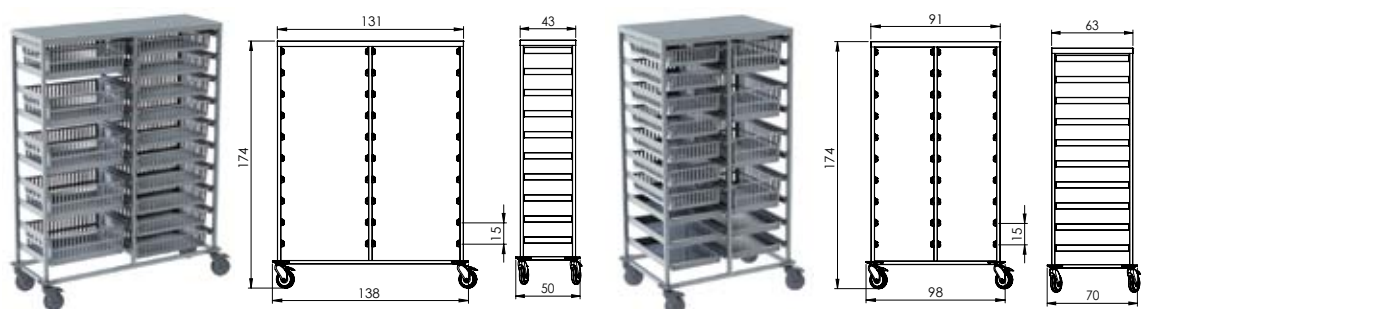

NEREZ5204*

basket standard size - 20 positions

NEREZ5214*

basket standard size - 20 positions

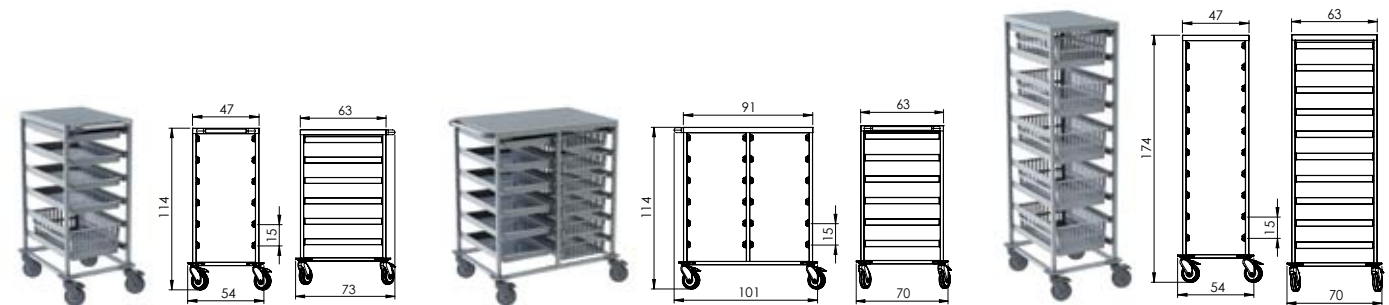

NEREZ5211*

basket standard size - 6 positions

NEREZ5212*

basket standard size - 12 positions

NEREZ5213*

basket standard size - 10 positions

MS basket S size (cat. No. 11419)
- occupies 1 position total (1 pair)



MS basket M size (cat. No. 11420)
- occupies 1 position total (1 pair)



MS basket L size (cat. No. 11421)
- occupies 2 positions total (2 pairs)



The individual basket sizes can be arbitrarily combined (with respect to the maximum number of positions).



Horizontal ledge
1 pair = 1 basket of all sizes
(40 cm length)
cat. No. 11427VAR02



Horizontal ledge
1 pair = 1 basket of all sizes
(60 cm length)
cat. No. 11427VAR01

Don't you know how to select? We will be happy to advise you! Toll free: +420 800 100 798

MULTIFUNCTIONAL CABINETS - MODULE SYSTEM

OPTIONS OF MS BASKET VARIABLE DIVISIONS

FOR ALL SIZES (5, 10, 20 CM) OF STANDARD MS BASKETS

MS basket dimensions (cm):

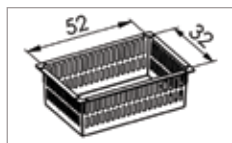

For all MS baskets - STANDARD line
Metal Line BASIC, PROFI - STANDARD, COMBI.

<p>OPTION 1</p>	<p>OPTION 2</p>	<p>OPTION 3</p>	<p>OPTION 4</p>	<p>OPTION 5</p>
<p>OPTION 6</p>	<p>OPTION 7</p>	<p>OPTION 8</p>	<p>OPTION 9</p>	<p>OPTION 10</p>
<p>OPTION 11</p>	<p>OPTION 12</p>	<p>OPTION 13</p>	<p>OPTION 14</p>	<p>OPTION 15</p>
<p>OPTION 16</p>	<p>OPTION 17</p>	<p>OPTION 18</p>	<p>OPTION 19</p>	<p>OPTION 20</p>
<p>OPTION 21</p>	<p>OPTION 22</p>	<p>OPTION 23</p>	<p>OPTION 24</p>	

Don't you know how to select? We will be happy to advise you! Toll free: +420 800 100 798

OPTIONS OF MS BASKET VARIABLE DIVISIONS

FOR 5 AND 10 CM HEIGHTS OF 3/4 AND 1/2 MS BASKETS

MS basket dimensions (cm):

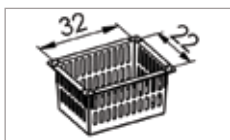

For 3/4 drawers (MS baskets - MINI) lines
Metal Line ECO - MAXI OPEN PLUS.

For 3/4 and 1/2 drawers (MS baskets - MINI) lines
Metal Line BASIC, PROFI - MINI, MAXI, COMBI, PICCOLO.

<p>OPTION 1</p>	<p>OPTION 2</p>	<p>OPTION 3</p>	<p>OPTION 4</p>	<p>OPTION 5</p>
<p>OPTION 6</p>	<p>OPTION 7</p>	<p>OPTION 8</p>	<p>OPTION 9</p>	<p>OPTION 10</p>
	<p>OPTION 11</p>	<p>OPTION 12</p>	<p>OPTION 13</p>	

FOR 20 CM HEIGHT 3/4 AND 1/2 MS BASKETS

<p>OPTION 1</p>	<p>OPTION 2</p>	<p>OPTION 3</p>
-----------------	-----------------	-----------------

For 3/4 drawers of sizes L, XL (MS baskets - MINI) lines
Metal Line ECO - MAXI OPEN PLUS.

For 3/4 and 1/2 drawers of sizes L, XL (MS baskets - MINI) lines
Metal Line BASIC, PROFI - MINI, MAXI, COMBI, PICCOLO.

MULTIFUNCTIONAL CARTS - MODULE SYSTEM

METAL LINE BASIC

We produce all the carts in two basic height variants and in different widths and lengths so that they can be incorporated into the existing equipment of medical rooms, patient wards and other operations and adapted to the fixed room equipment in colour and dimensions.

**It is upon you which types you choose and assemble.
We will satisfy your requirements and preferences.**



For transportation and handling of various medical materials, drugs, documentation, instruments, etc., you can use open or closed types of carts, cabinet carts, drawer carts or shutter lockable carts. Carts can be equipped with a large number of complements per the actual need.

Don't you know how to select? We will be happy to advise you! Toll free: +420 800 100 798

MULTIFUNCTIONAL CARTS - MODULE SYSTEM

METAL LINE BASIC - STANDARD DRAWER CARTS

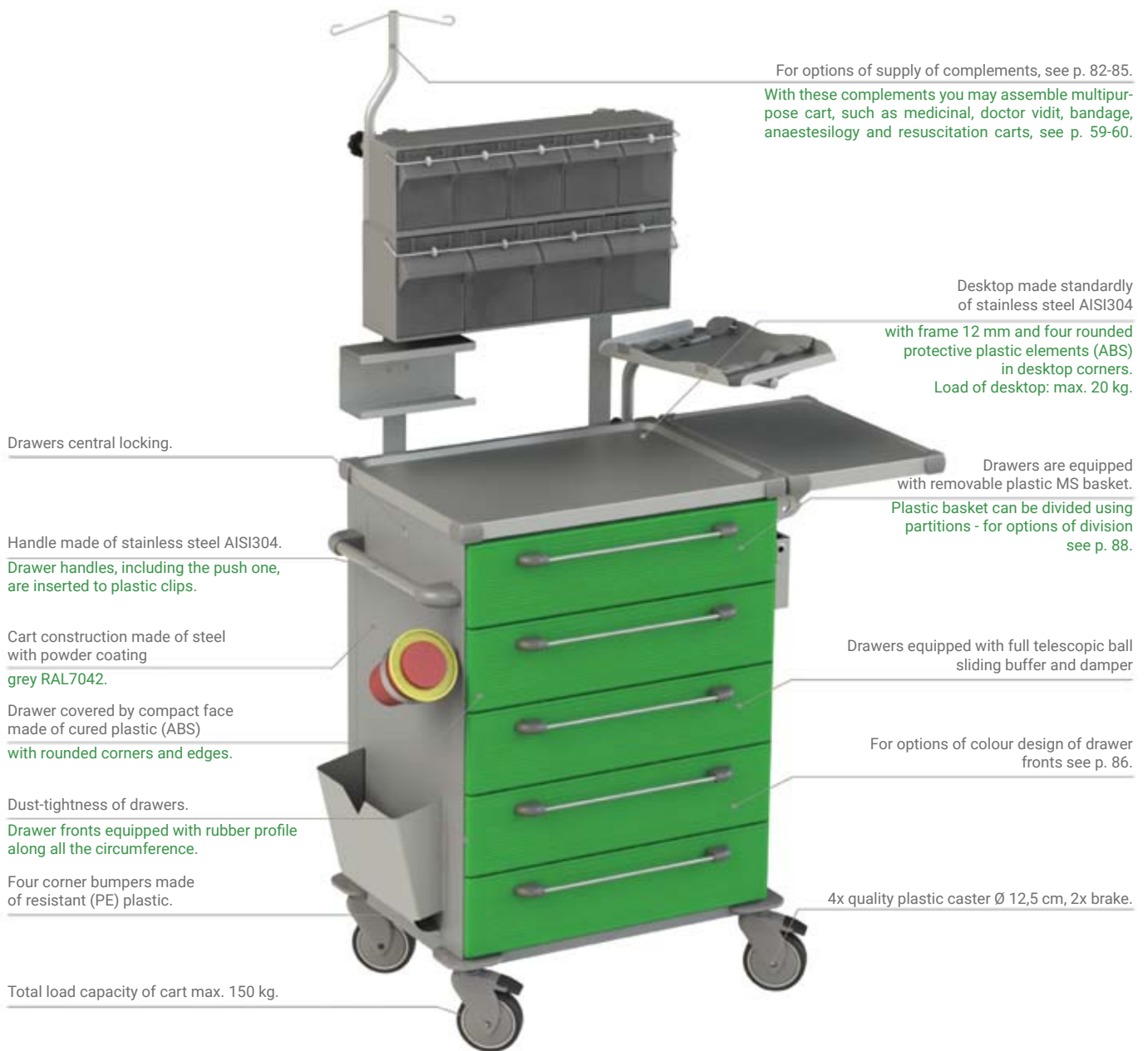

METAL LINE BASIC

CARTS WITH ROLLER SHUTTER, DOCUMENTATION CARTS, CABINET CARTS



Don't you know how to select? We will be happy to advise you! Toll free: +420 800 100 798



MULTIFUNCTIONAL CARTS - MODULE SYSTEM

METAL LINE BASIC - STANDARD

DRAWER CARTS

width 75 cm x depth 55 cm

LOW VERSION

(height 89 cm)

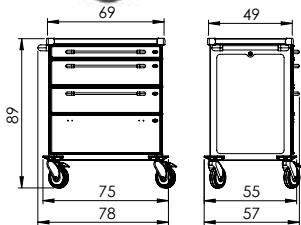

HIGH VERSION

(height 105 cm)

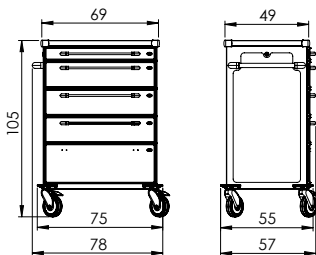

Internal division of MS baskets, see p. 88.

Choose the variant of your cart according to the height of individual drawers:

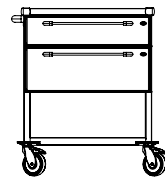

ZV1200N*
1x drawer M
1x drawer L
1x fixed shelf (bottom)

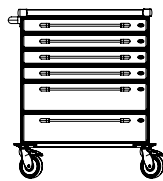

ZV1201N*
4x drawer S
2x drawer M

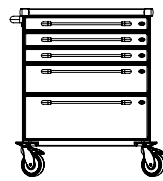

ZV1202N*
3x drawer S
1x drawer M
1x drawer L

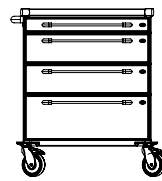

ZV1203N*
1x drawer S
2x drawer M
1x drawer L

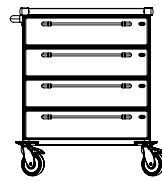

ZV1204N*
4x drawer M

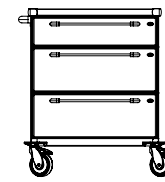

ZV1205N*
1x drawer M
2x drawer L

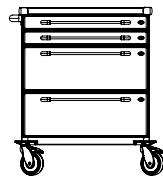

ZV1206N*
2x drawer S
2x drawer L

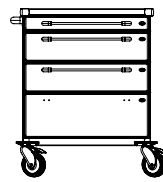

ZV1207N*
1x drawer S
1x drawer M
1x drawer XL

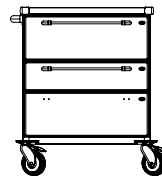

ZV1208N*
1x drawer L
1x drawer XL

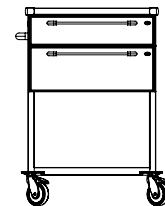

ZV1250N*
1x drawer M
1x drawer L
1x fixed shelf (bottom)

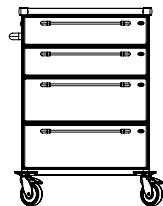

ZV1251N*
2x drawer M
2x drawer L

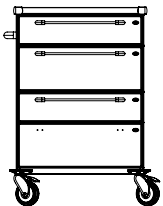

ZV1252N*
1x drawer M
1x drawer L
1x drawer XL

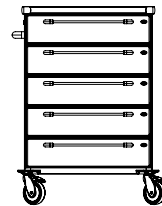

ZV1253N*
5x drawer M

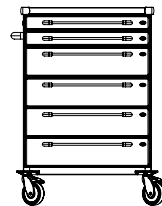

ZV1254N*
2x drawer S
4x drawer M

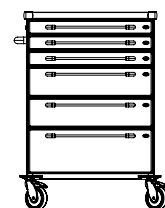

ZV1255N*
3x drawer S
2x drawer M
1x drawer L

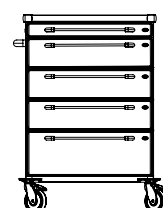

ZV1256N*
1x drawer S
3x drawer M
1x drawer L

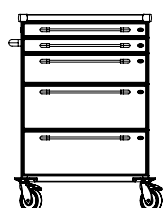

ZV1257N*
2x drawer S
1x drawer M
2x drawer M

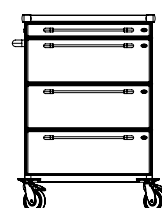

ZV1258N*
1x drawer S
3x drawer L

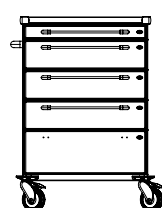

ZV1259N*
1x drawer S
2x drawer M
1x drawer XL

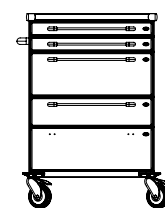

ZV1260N*
2x drawer S
1x drawer L
1x drawer XL

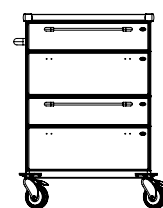

ZV1261N*
2x drawer XL

MS drawer S size:

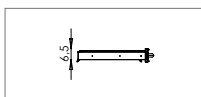

MS drawer M size:

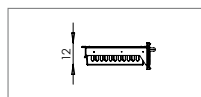

MS drawer L size:

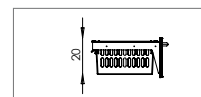

MS drawer XL size:

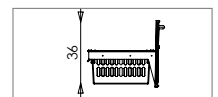

Don't you know how to select? We will be happy to advise you! Toll free: +420 800 100 798

MULTIFUNCTIONAL CARTS - MODULE SYSTEM

Basic open versions of carts allow hanging MS baskets of different sizes based on the size of material.

In addition to the basic open version of carts for transport of MS baskets, we offer carts fitted with lockable shutter, drawer carts, cabinet carts with MS baskets or shelves or different types of carts can be combined.

Enclosed carts include the option of central lock and dust-tightness. Both versions of carts can be equipped with a working bench made of stainless steel and a copious number of complements.



METAL LINE BASIC



Don't you know how to select? We will be happy to advise you! Toll free: +420 800 100 798

MULTIFUNCTIONAL CARTS - MODULE SYSTEM

METAL LINE BASIC - STANDARD

ROLLING SHUTTER CARTS width 75 cm x depth 55 cm

LOW VERSION (height 89 cm)

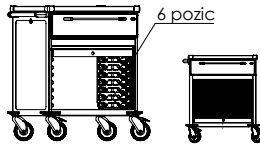
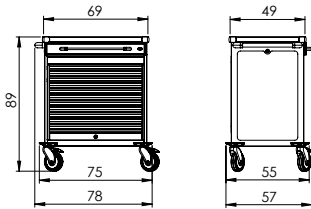

ZV1211N*
1x drawer M
6 positions

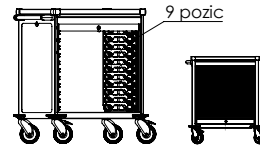

ZV1212N*
9 positions

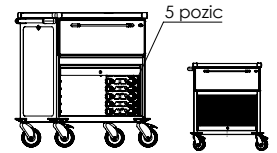

ZV1213N*
1x drawer L
5 positions

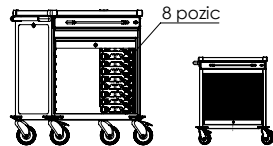

ZV1214N*
1x drawer S
8 positions

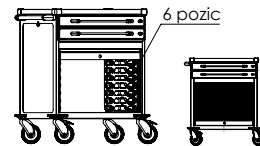

ZV1215N*
2x drawer S
6 positions

HIGH VERSION (height 105 cm)

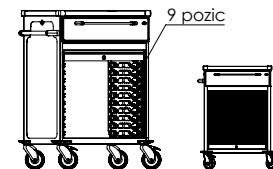
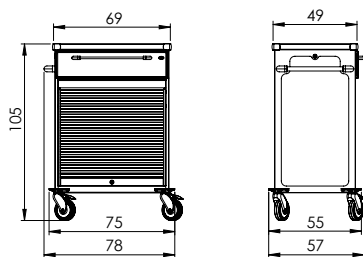

ZV1267N*
1x drawer M
9 positions

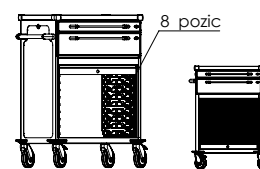

ZV1269N*
1x drawer S
1x drawer M
8 positions

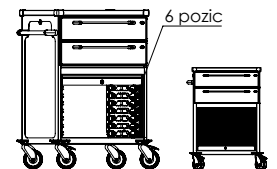

ZV1271N*
2x drawer M
6 positions

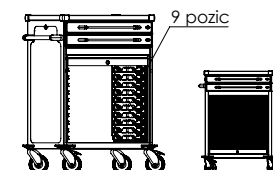

ZV1272N*
2x drawer S
9 positions

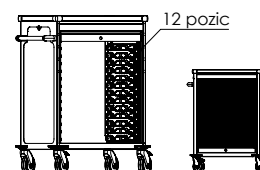

ZV1273N*
12 positions

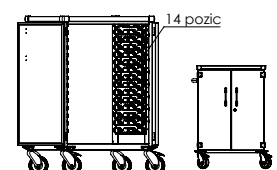

ZV1295N*
1x double door
14 positions

MS basket S size
(cat. No. 11419)
occupies 2 positions

MS basket M size
(cat. No. 11420)
occupies 3 positions

MS basket L size
(cat. No. 11421)
occupies 5 positions

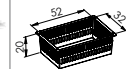
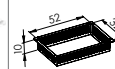
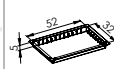

Internal division of MS baskets, see p. 88.

Choose the variant of your cart according to the height of individual drawers:

MS drawer S size:

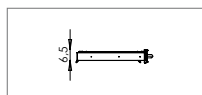

MS drawer M size:

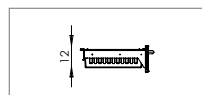

MS drawer L size:

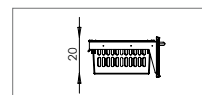

Don't you know how to select? We will be happy to advise you! Toll free: +420 800 100 798



MULTIFUNCTIONAL CARTS - MODULE SYSTEM

METAL LINE BASIC - STANDARD

DOCUMENTATION CARTS

width 78 cm x depth 65 cm

LOW VERSION

(height 92 cm)

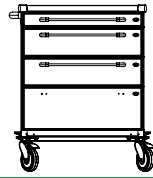
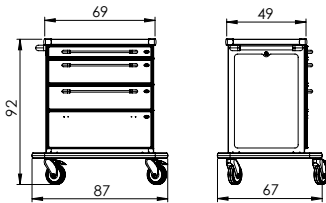

ZV1209N*

1x drawer S
1x drawer M
1x drawer XL
with divider

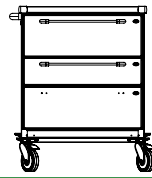

ZV1210N*

1x drawer L
1x drawer XL
with divider

Extended support made of the stainless steel AISI304 provides stability at full load, and also when the documentation drawer is fully pulled out.

HIGH VERSION

(height 108 / 105 cm)

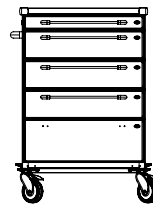
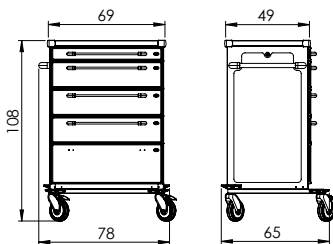

ZV1262N*

1x drawer S
2x drawer M
1x drawer XL
with divider

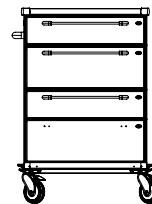

ZV1263N*

1x drawer M
1x drawer L
1x drawer XL
with divider

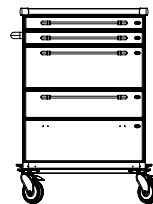

ZV1264N*

2x drawer S
1x drawer L
1x drawer XL
with divider

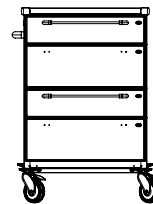

ZV1265N*

1x drawer XL
1x drawer XL
with divider

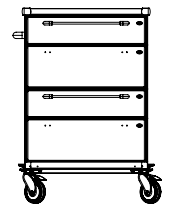

ZV1266N*

2x drawer XL
with divider

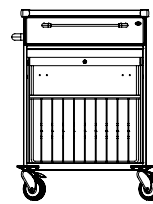

ZV1280N*

cart height: 105 cm
1x drawer M
1x divider for 10
medical documenta-
tion files

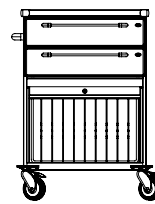

ZV1281N*

cart height: 105 cm
2x drawer M
1x divider for 10
medical documenta-
tion files

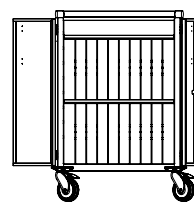

ZV1294N*

cart height: 105 cm
2x divider for 10
medical
documentation files

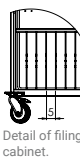

Detail of filing
cabinet.

Internal division of MS baskets, see p. 88.

Choose the variant of your cart according to the height of individual drawers:



MS drawer S size:

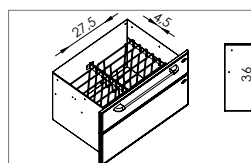
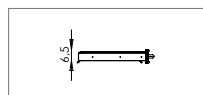

MS drawer M size:

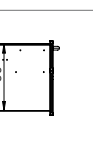
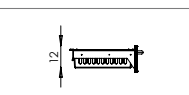

MS drawer L size:

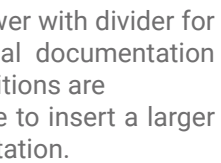
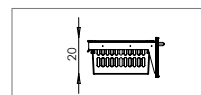

MS drawer XL size:

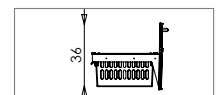

Steel drawer with divider for 16 medical documentation files. Partitions are removable to insert a larger documentation.

Don't you know how to select? We will be happy to advise you! Toll free: +420 800 100 798



MULTIFUNCTIONAL CARTS - MODULE SYSTEM

METAL LINE BASIC - COMBI

METAL LINE BASIC

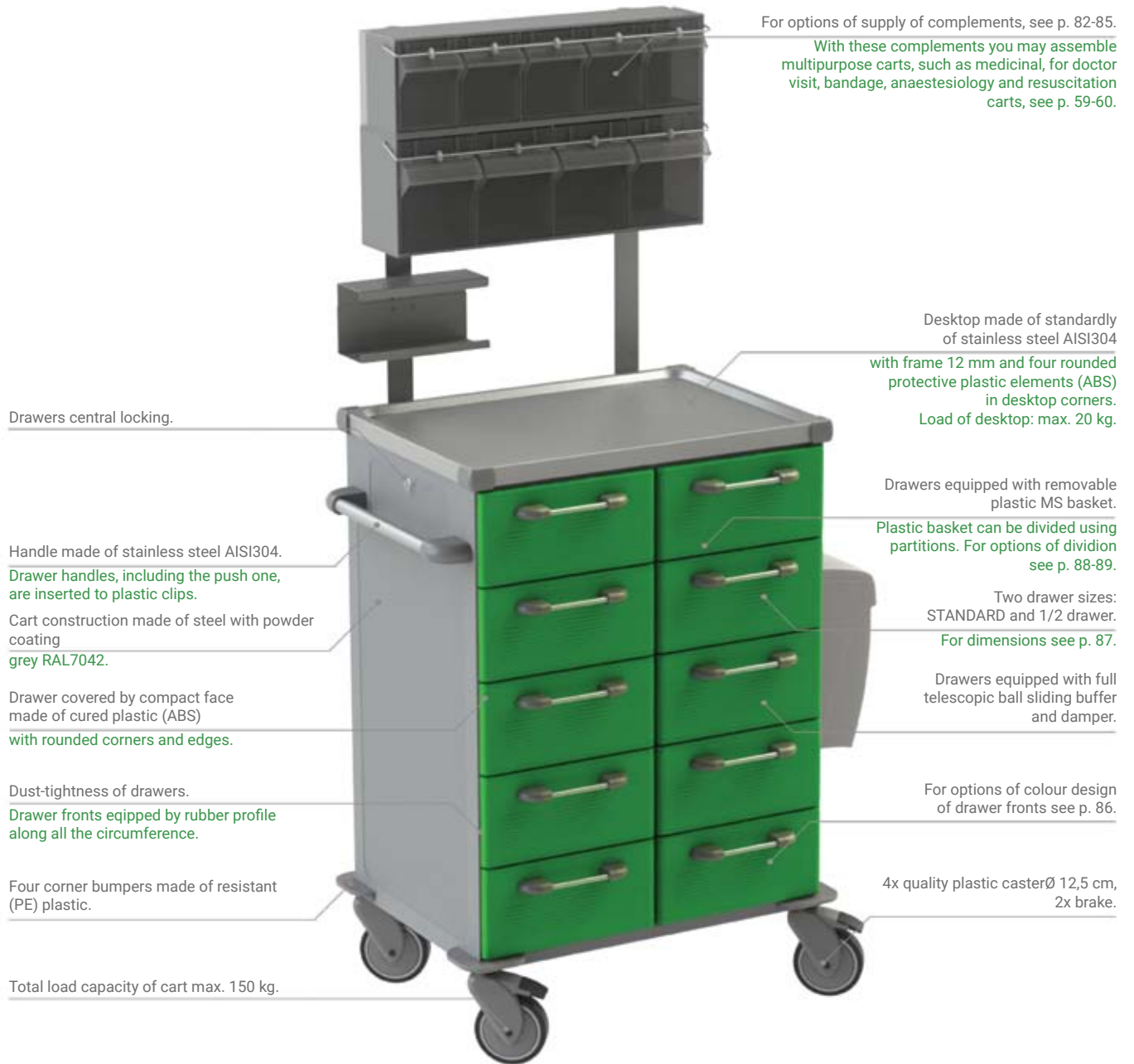

Choose the variant of your cart according to the height of individual drawers:

MS drawer S size:

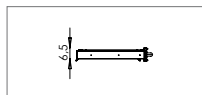

MS drawer M size:

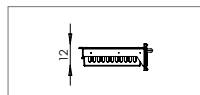

MS drawer L size:

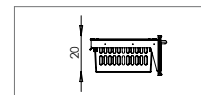

MS drawer XL size:

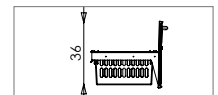

Internal division of MS baskets, see p. 88-89.

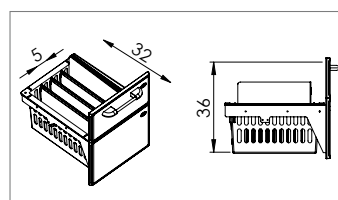

1/2 drawer with divider equipped with a plastic MS basket divided by removable partitions.

Don't you know how to select? We will be happy to advise you! Toll free: +420 800 100 798

MULTIFUNCTIONAL CARTS - MODULE SYSTEM

METAL LINE BASIC - COMBI

width 75 cm x depth 55 cm

LOW VERSION
(height 89 cm)

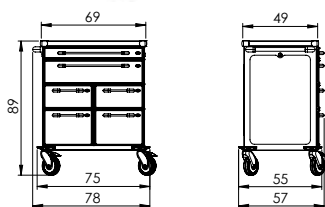

METAL LINE BASIC

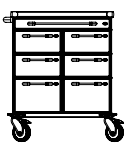

ZV2201N*

1x drawer S
4x 1/2 drawer M
2x 1/2 drawer L

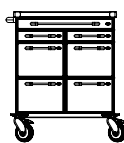

ZV2202N*

1x drawer S
2x 1/2 drawer S
4x 1/2 drawer L

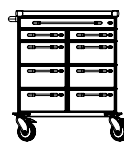

ZV2203N*

1x drawer S
2x 1/2 drawer S
6x 1/2 drawer M

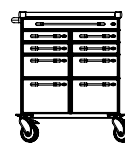

ZV2204N*

1x drawer S
4x 1/2 drawer S
2x 1/2 drawer M
2x 1/2 drawer L

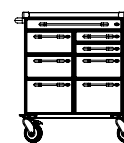

ZV2205N*

1x drawer S
2x 1/2 drawer S
3x 1/2 drawer M
2x 1/2 drawer L

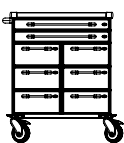

ZV2206N*

2x drawer S
6x 1/2 drawer M

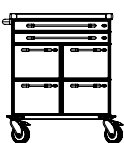

ZV2207N*

2x drawer S
4x 1/2 drawer L

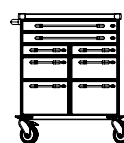

ZV2208N*

2x drawer S
2x 1/2 drawer S
2x 1/2 drawer M
2x 1/2 drawer L



ZV2209N*

2x drawer S
2x 1/2 drawer S
5x 1/2 drawer M

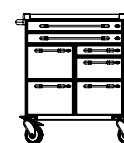

ZV2210N*

2x drawer S
1x 1/2 drawer S
1x 1/2 drawer M
3x 1/2 drawer L

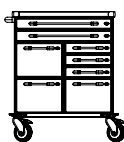

ZV2211N*

2x drawer S
3x 1/2 drawer S
3x 1/2 drawer L

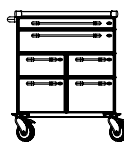

ZV2212N*

1x drawer S and M
2x 1/2 drawer M
2x 1/2 drawer L

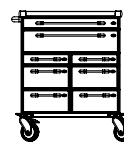

ZV2213N*

1x drawer S and M
2x 1/2 drawer S
4x 1/2 drawer M

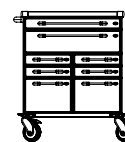

ZV2214N*

1x drawer S and M
4x 1/2 drawer S
2x 1/2 drawer L

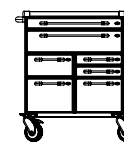

ZV2215N*

1x drawer S and M
2x 1/2 drawer S
1x 1/2 drawer M
2x 1/2 drawer L

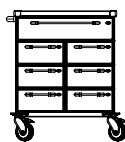

ZV2216N*

1x drawer M
6x 1/2 drawer M



ZV2217N*

1x drawer M
4x 1/2 drawer L

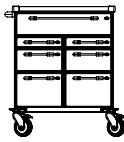

ZV2218N*

1x drawer M
2x 1/2 drawer S
2x 1/2 drawer M
2x 1/2 drawer L

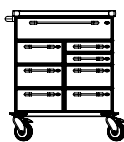

ZV2219N*

1x drawer M
2x 1/2 drawer S
5x 1/2 drawer M

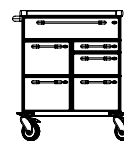

ZV2220N*

1x drawer M
1x 1/2 drawer S
1x 1/2 drawer M
3x 1/2 drawer L



ZV2221N*

2x drawer M
4x 1/2 drawer M

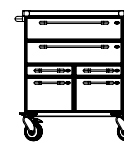

ZV2222N*

2x drawer M
2x 1/2 drawer S
2x 1/2 drawer L

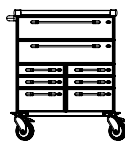

ZV2223N*

2x drawer M
4x 1/2 drawer S
2x 1/2 drawer M



ZV2224N*

2x drawer M
2x 1/2 drawer S
3x 1/2 drawer M



ZV2225N*

1x drawer S and M
2x 1/2 drawer XL

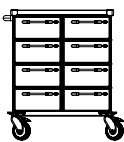

ZV2227N*

8x 1/2 drawer M

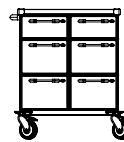

ZV2228N*

2x 1/2 drawer M
4x 1/2 drawer L

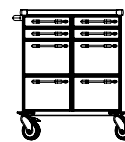

ZV2229N*

4x 1/2 drawer S
4x 1/2 drawer L



ZV2230N*

2x 1/2 drawer S
2x 1/2 drawer M
2x 1/2 drawer XL



ZV2231N*

2x 1/2 drawer L
2x 1/2 drawer XL

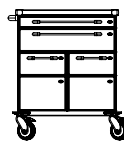

ZV2232N*

1x drawer S and M
2x 1/2 drawer XL

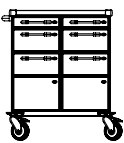

ZV2233N*

2x 1/2 drawer S
2x 1/2 drawer M
2x 1/2 drawer XL
with divider

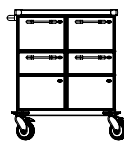

ZV2234N*

2x 1/2 drawer L
2x 1/2 drawer XL
with divider

Don't you know how to select? We will be happy to advise you! Toll free: +420 800 100 798

MULTIFUNCTIONAL CARTS - MODULE SYSTEM

METAL LINE BASIC - COMBI

width 75 cm x depth 55 cm

HIGH VERSION
height 105 cm)

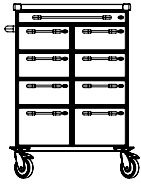
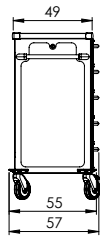
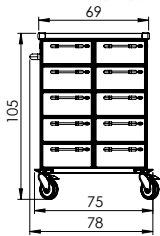

ZV2250N*

1x drawer S
6x 1/2 drawer M
2x 1/2 drawer L

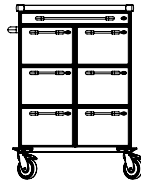

ZV2251N*

1x drawer S
6 1/2 drawer L

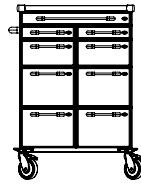

ZV2252N*

1x drawer S
2x 1/2 drawer S
2x 1/2 drawer M
4x 1/2 drawer L

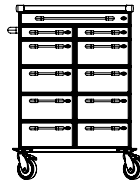

ZV2253N*

1x drawer S
2x 1/2 drawer S
8x 1/2 drawer M

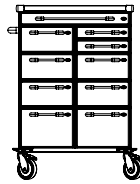

ZV2254N*

1x drawer S
2x 1/2 drawer S
5x 1/2 drawer M
2x 1/2 drawer L

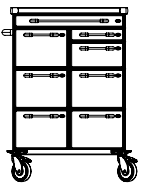

ZV2255N*

1x drawer S
1x 1/2 drawer S
1x 1/2 drawer M
5x 1/2 drawer L

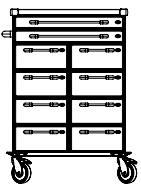

ZV2256N*

2x drawer S
8x 1/2 drawer M

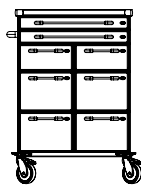

ZV2257N*

2x drawer S
2x 1/2 drawer M
4x 1/2 drawer L

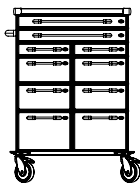

ZV2258N*

2x drawer S
2x 1/2 drawer S
4x 1/2 drawer M
2x 1/2 drawer L

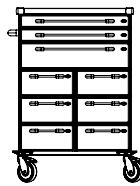

ZV2259N*

2x drawer S
1x drawer M
6x 1/2 drawer M

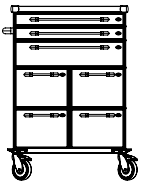

ZV2260N*

2x drawer S
1x drawer M
4x 1/2 drawer L

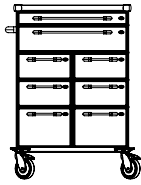

ZV2261N*

1x drawer S and M
4x 1/2 drawer M
2x 1/2 drawer L

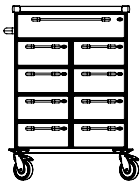

ZV2262N*

1x drawer M
8x 1/2 drawer M

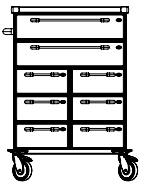

ZV2263N*

2x drawer M
6x 1/2 drawer M

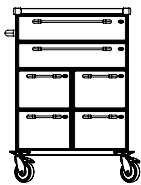

ZV2264N*

2x drawer M
4x 1/2 drawer L

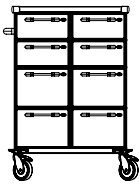

ZV2265N*

4x 1/2 drawer M
4x 1/2 drawer L

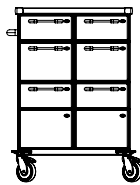

ZV2266N*

2x 1/2 drawer M
2x 1/2 drawer L
2x 1/2 drawer XL

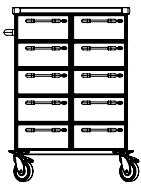

ZV2267N*

10x 1/2 drawer M

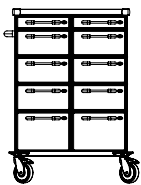

ZV2268N*

2x 1/2 drawer S
6x 1/2 drawer M
2x 1/2 drawer L

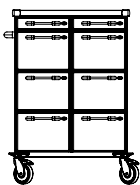

ZV2269N*

2x 1/2 drawer S
6x 1/2 drawer L

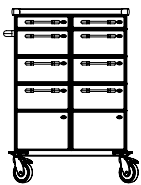

ZV2270N*

2x 1/2 drawer S
4x 1/2 drawer M
2x 1/2 drawer XL

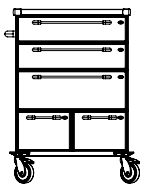

ZV2271N*

2x drawer M
1x drawer L
2x 1/2 drawer L

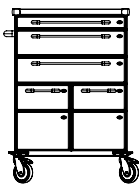

ZV2272N*

1x drawer S
2x drawer M
2x 1/2 drawer XL

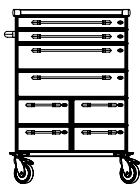

ZV2273N*

2x drawer S and M
4x 1/2 drawer M

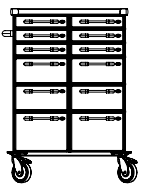

ZV2274N*

6x 1/2 drawer S
4x 1/2 drawer M
2x 1/2 drawer L

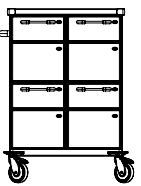

ZV2276N*

4x 1/2 drawer XL

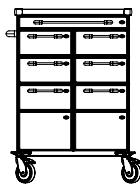

ZV2277N*

1x drawer S
4x 1/2 drawer M
2x 1/2 drawer XL

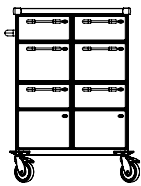

ZV2278N*

2x 1/2 drawer M
2x 1/2 drawer L
2x 1/2 drawer XL
with divider

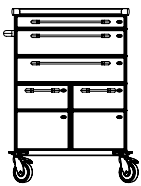

ZV2279N*

1x drawer S
2x drawer M
2x 1/2 drawer XL
with divider

METAL LINE BASIC

Don't you know how to select? We will be happy to advise you! Toll free: +420 800 100 798

MULTIFUNCTIONAL CARTS - MODULE SYSTEM

METAL LINE BASIC - MAXI

METAL LINE BASIC



Choose the variant of your cart according to the height of individual drawers:



MS drawer S size:

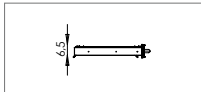

MS drawer M size:

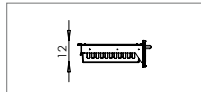

MS drawer L size:

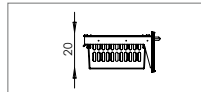

MS drawer XL size:

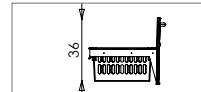

Internal division of MS baskets, see p. 89.

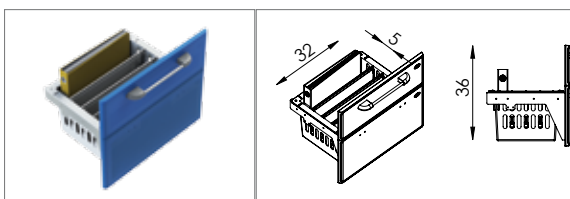

3/4 drawer with divider equipped with a plastic MS basket divided by removable partitions.

Don't you know how to select? We will be happy to advise you! Toll free: +420 800 100 798

MULTIFUNCTIONAL CARTS - MODULE SYSTEM

METAL LINE BASIC - MAXI

width 102 cm x depth 50 cm

LOW VERSION
(height 89 cm)

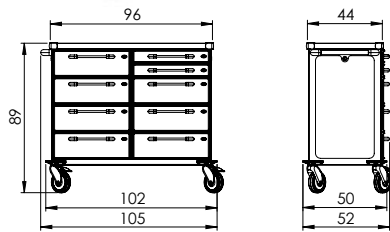

HIGH VERSION
(height 105 cm)

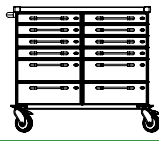
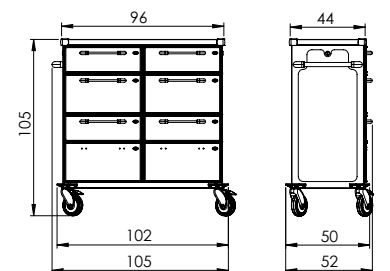

ZV4201N*

8x 3/4 drawer S
4x 3/4 drawer M

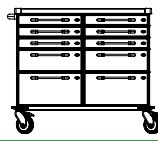

ZV4202N*

6x 3/4 drawer S
2x 3/4 drawer M
2x 3/4 drawer L

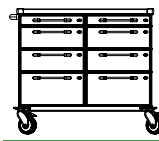

ZV4203N*

2x 3/4 drawer S
4x 3/4 drawer M
2x 3/4 drawer L



ZV4204N*

8x 3/4 drawer M

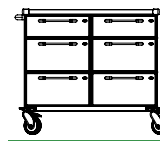

ZV4205N*

2x 3/4 drawer M
4x 3/4 drawer L

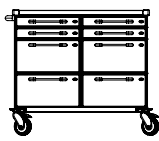

ZV4206N*

4x 3/4 drawer S
4x 3/4 drawer L



ZV4208N*

2x 3/4 drawer L
2x 3/4 drawer XL

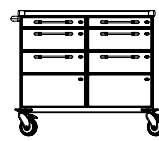

ZV4209N*

2x 3/4 drawer S
2x 3/4 drawer M
2x 3/4 drawer XL

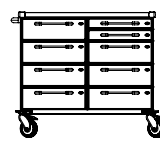

ZV4211N*

2x 3/4 drawer S
7x 3/4 drawer M

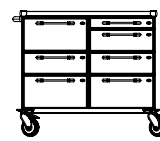

ZV4212N*

1x 3/4 drawer S
3x 3/4 drawer M
3x 3/4 drawer L



ZV4213N*

2x 3/4 drawer L
2x 3/4 drawer XL
with divider



ZV4214N*

2x 3/4 drawer S
2x 3/4 drawer M
2x 3/4 drawer XL
with divider

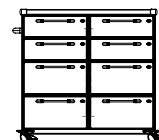

ZV4251N*

4x 3/4 drawer M
4x 3/4 drawer L

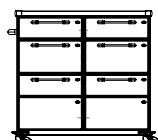

ZV4252N*

2x 3/4 drawer M
2x 3/4 drawer L
2x 3/4 drawer XL

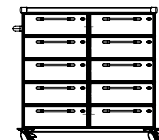

ZV4253N*

10x 3/4 drawer M

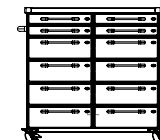

ZV4254N*

4x 3/4 drawer S
8x 3/4 drawer M

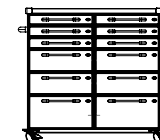

ZV4255N*

6x 3/4 drawer S
4x 3/4 drawer M
2x 3/4 drawer L

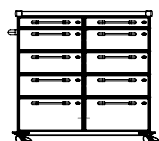

ZV4256N*

2x 3/4 drawer S
6x 3/4 drawer M
2x 3/4 drawer L

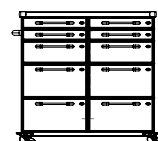

ZV4257N*

4x 3/4 drawer S
2x 3/4 drawer M
4x 3/4 drawer L

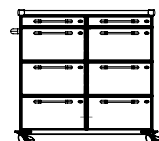

ZV4258N*

2x 3/4 drawer S
6x 3/4 drawer L

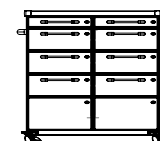

ZV4259N*

2x 3/4 drawer S
4x 3/4 drawer M
2x 3/4 drawer XL

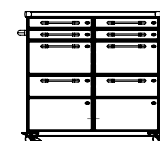

ZV4260N*

4x 3/4 drawer S
2x 3/4 drawer L
2x 3/4 drawer XL

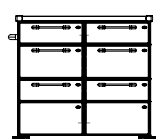

ZV4261N*

2x 3/4 drawer M
2x 3/4 drawer L
2x 3/4 drawer XL
with divider

METAL LINE BASIC

Don't you know how to select? We will be happy to advise you! Toll free: +420 800 100 798



MULTIFUNCTIONAL CARTS - MODULE SYSTEM

METAL LINE BASIC - MINI



METAL LINE BASIC



Choose the variant of your cart according to the height of individual drawers:



Internal division of MS baskets, see p. 89.

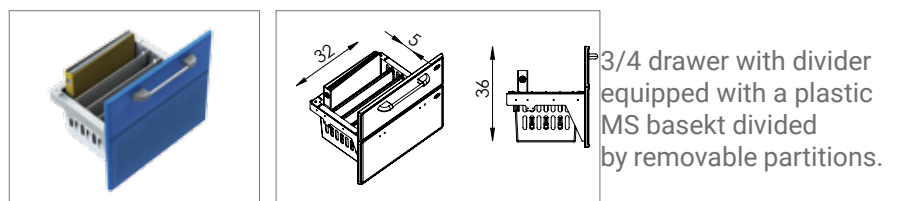

Don't you know how to select? We will be happy to advise you! Toll free: +420 800 100 798

MULTIFUNCTIONAL CARTS - MODULE SYSTEM

METAL LINE BASIC - MINI

width 55 cm x depth 50 cm

LOW VERSION

(height 89 cm)

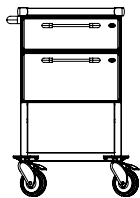
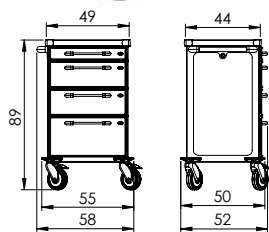

ZV3200N*
1x 3/4 drawer M
1x 3/4 drawer L
1x fixed shelf (bottom)

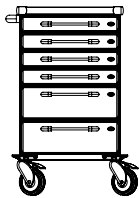

ZV3201N*
4x 3/4 drawer S
2x 3/4 drawer M

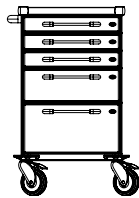

ZV3202N*
3x 3/4 drawer S
1x 3/4 drawer M
1x 3/4 drawer L

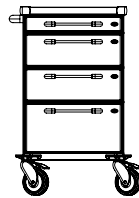

ZV3203N*
1x 3/4 drawer S
2x 3/4 drawer M
1x 3/4 drawer L

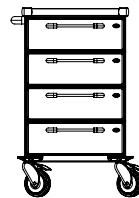

ZV3204N*
4x 3/4 drawer M

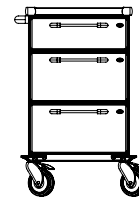

ZV3205N*
1x 3/4 drawer M
2x 3/4 drawer L

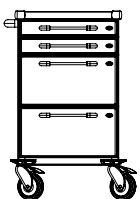

ZV3206N*
2x 3/4 drawer S
2x 3/4 drawer L

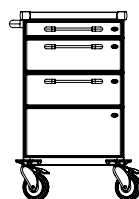

ZV3207N*
1x 3/4 drawer S
1x 3/4 drawer M
1x 3/4 drawer XL

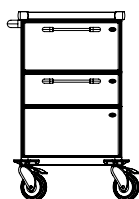

ZV3208N*
1x 3/4 drawer L
1x 3/4 drawer XL

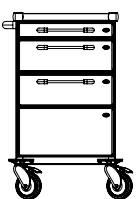

ZV3209N*
1x 3/4 drawer S
1x 3/4 drawer M
1x 3/4 drawer XL
with divider

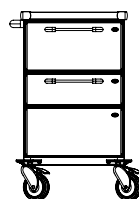

ZV3210N*
1x 3/4 drawer L
1x 3/4 drawer XL
with divider

HIGH VERSION

(height 105 cm)

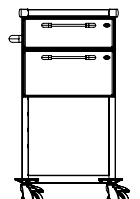
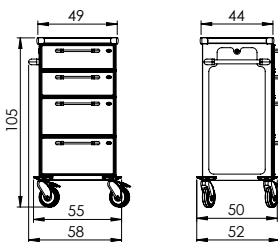

ZV3250N*
1x 3/4 drawer M
1x 3/4 drawer L
1x fixed shelf (bottom)

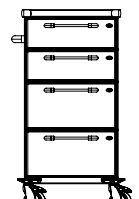

ZV3251N*
2x 3/4 drawer M
2x 3/4 drawer L

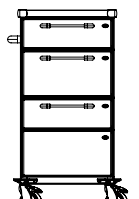

ZV3252N*
1x 3/4 drawer M
1x 3/4 drawer L
1x 3/4 drawer XL

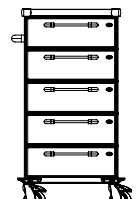

ZV3253N*
5x 3/4 drawer M

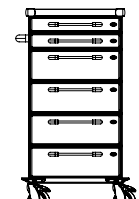

ZV3254N*
2x 3/4 drawer S
4x 3/4 drawer M

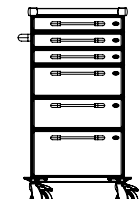

ZV3255N*
3x 3/4 drawer S
2x 3/4 drawer M
1x 3/4 drawer L

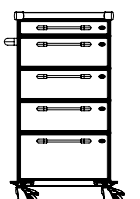

ZV3256N*
1x 3/4 drawer S
3x 3/4 drawer M
1x 3/4 drawer L

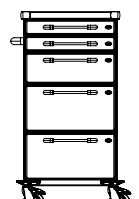

ZV3257N*
2x 3/4 drawer S
1x 3/4 drawer M
2x 3/4 drawer L

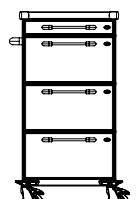

ZV3258N*
1x 3/4 drawer S
3x 3/4 drawer L

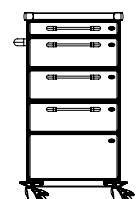

ZV3259N*
1x 3/4 drawer S
2x 3/4 drawer M
1x 3/4 drawer XL

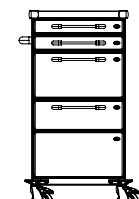

ZV3260N*
2x 3/4 drawer S
1x 3/4 drawer L
1x 3/4 drawer XL

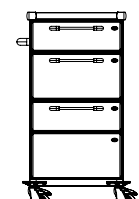

ZV3263N*
1x 3/4 drawer M
1x 3/4 drawer L
1x 3/4 drawer XL
with divider

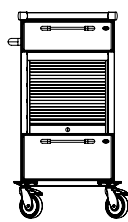

ZV3270N*
1x lockable roller shutter
1x 3/4 drawer M
1x 3/4 drawer L
2x fixed shelf

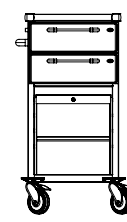

ZV3271N*
1x lockable roller shutter
2x 3/4 drawer M
2x fixed shelf

Don't you know how to select? We will be happy to advise you! Toll free: +420 800 100 798

MULTIFUNCTIONAL CARTS - MODULE SYSTEM

Our products can be mutually combined – cabinets, racks, desks, sinks, etc. to complement carts of various types in different material and colour design according to your selection and demands of your workplace.

We offer complete equipment of your rooms. Fixed equipment, such as cabinets, shelves, stainless steel sinks, desks, corner fittings, etc.

Room can be equipped with colour-matched handling carts of any material and colour design according to your selection and demands of your workplace.



METAL LINE BASIC



Don't you know how to select? We will be happy to advise you! Toll free: +420 800 100 798

MULTIFUNCTIONAL CARTS - MODULE SYSTEM

Other examples of room equipment are fixed cabinets for deposit of MS baskets and the desk complemented with various types of drawer carts.

Individual carts and parts can be mutually combined and complemented. Just as you wish.

Our products are distinguished by their detailed elaboration using latest technologies.



Don't you know how to select? We will be happy to advise you! Toll free: +420 800 100 798

MULTIFUNCTIONAL CARTS - MODULE SYSTEM

METAL LINE BASIC - PICCOLO

width 41 cm x depth 55 cm



METAL LINE BASIC

LOW VERSION ONLY (height 89 cm)

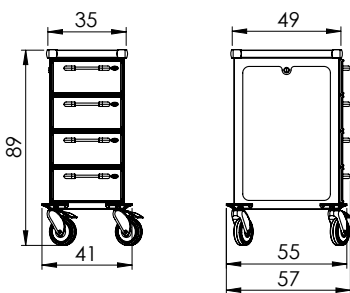

Internal division of MS baskets, see p. 89.

Choose the variant of your cart according to the height of individual drawers:

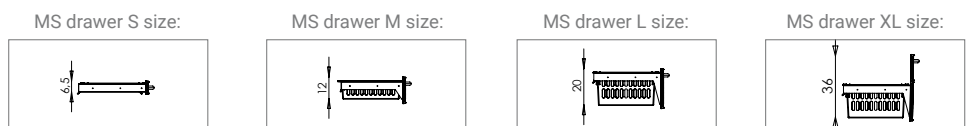

Don't you know how to select? We will be happy to advise you! Toll free: +420 800 100 798

MULTIFUNCTIONAL CARTS - MODULE SYSTEM

We offer a wide range of colours. Our products can be matched with colours of the interior space. Each department may have its own colour of carts. It is very practical.

Colours of fronts of drawers and doors can be arbitrarily combined.

Carts can be of multicolour design so that you like to watch them and they match the interior space as well.

Which colours are you going to choose?



Don't you know how to select? We will be happy to advise you! Toll free: +420 800 100 798

MULTIFUNCTIONAL CARTS - MODULE SYSTEM

METAL LINE PROFI - STANDARD DRAWER CARTS

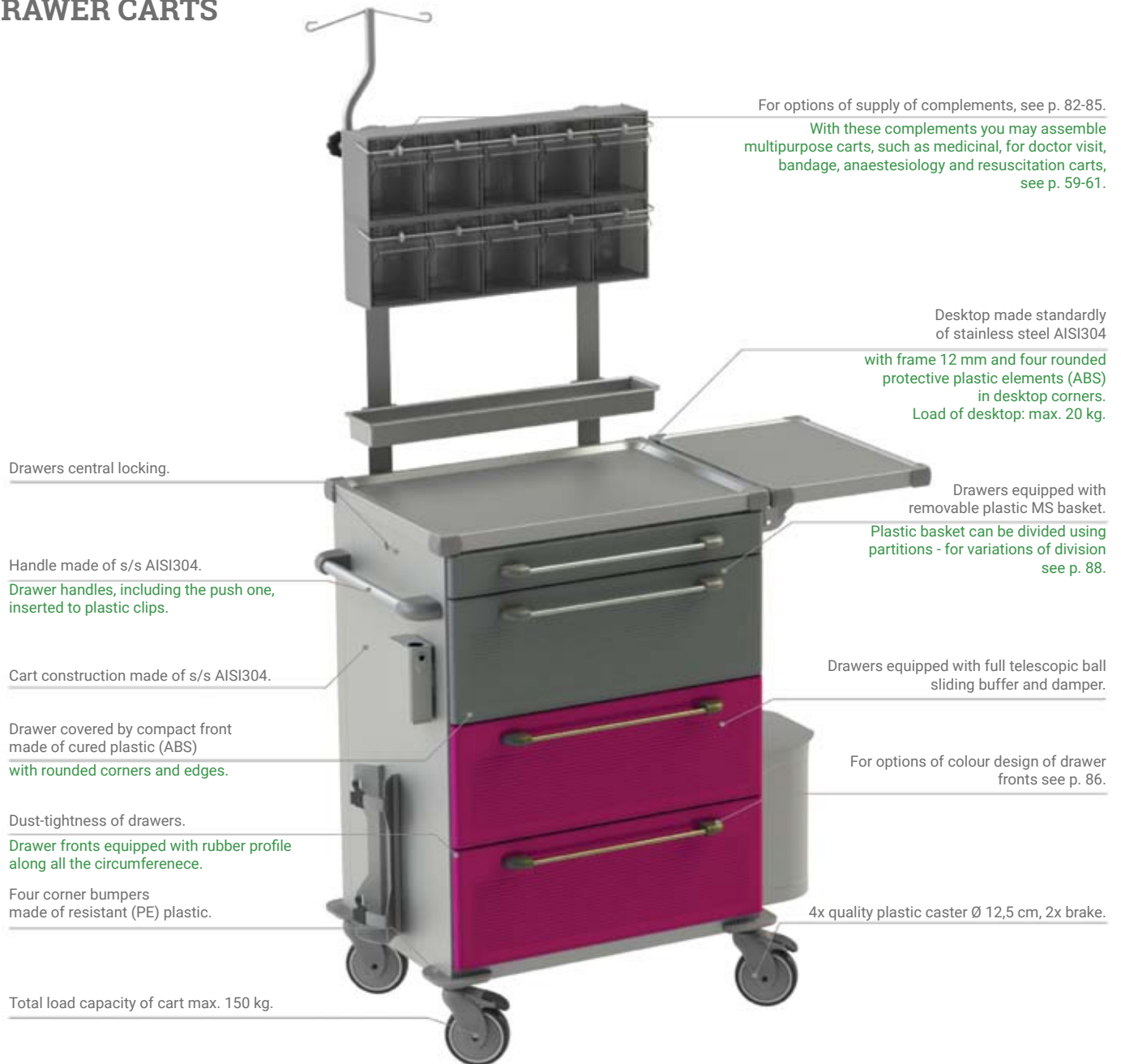

METAL LINE PROFI

CARTS WITH ROLLER SHUTTER, DOCUMENTATION CARTS, CABINET CARTS



Don't you know how to select? We will be happy to advise you! Toll free: +420 800 100 798

MULTIFUNCTIONAL CARTS - MODULE SYSTEM

METAL LINE PROFI - STANDARD

DRAWER CARTS

width 75 cm x depth 55 cm

LOW VERSION

(height 89 cm)

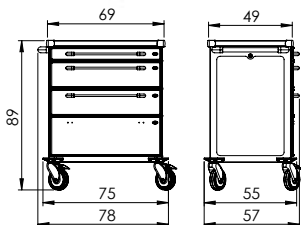

HIGH VERSION

(height 105 cm)

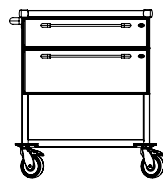
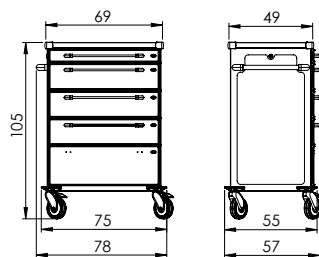

ZV1300N*
1x drawer M
1x drawer L
1x fixed shelf (bottom)

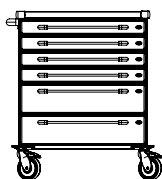

ZV1301N*
4x drawer S
2x drawer M

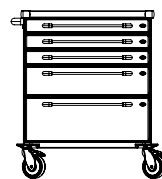

ZV1302N*
3x drawer S
1x drawer M
1x drawer L

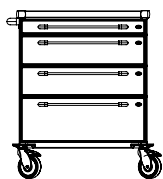

ZV1303N*
1x drawer S
2x drawer M
1x drawer L

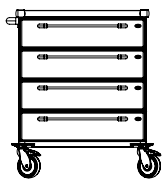

ZV1304N*
4x drawer M

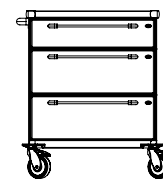

ZV1305N*
1x drawer M
2x drawer L

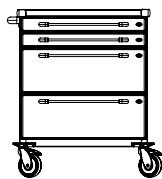

ZV1306N*
2x drawer S
2x drawer L

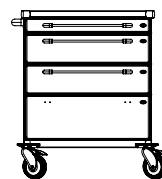

ZV1307N*
1x drawer S
1x drawer M
1x drawer XL

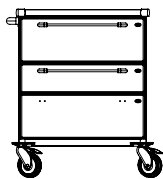

ZV1308N*
1x drawer L
1x drawer XL

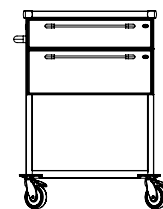

ZV1350N*
1x drawer M
1x drawer L
1x fixed shelf (bottom)

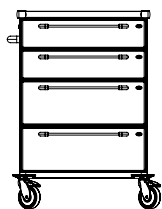

ZV1351N*
2x drawer M
2x drawer L

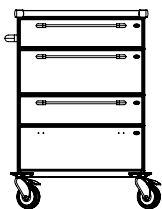

ZV1352N*
1x drawer M
1x drawer L
1x drawer XL

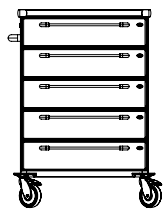

ZV1353N*
5x drawer M

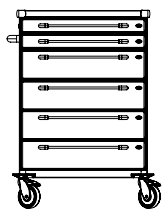

ZV1354N*
2x drawer S
4x drawer M

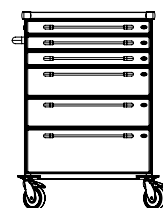

ZV1355N*
3x drawer S
2x drawer M
1x drawer L

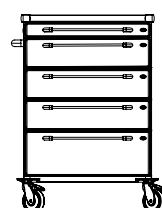

ZV1356N*
1x drawer S
3x drawer M
1x drawer L

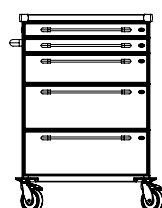

ZV1357N*
2x drawer S
1x drawer M
2x drawer L

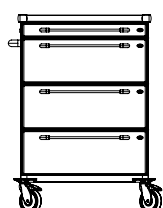

ZV1358N*
1x drawer S
3x drawer L

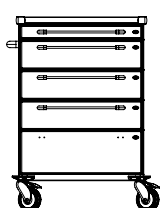

ZV1359N*
1x drawer S
2x drawer M
1x drawer XL

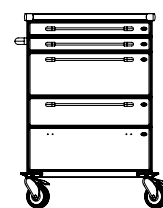

ZV1360N*
2x drawer S
1x drawer L
1x drawer XL

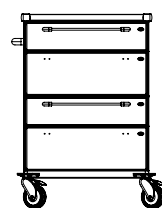

ZV161N*
2x drawer XL

Internal division of MS baskets, see p. 88.

Choose the variant of your cart according to the height of individual drawers:

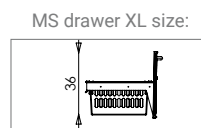
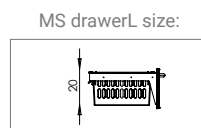
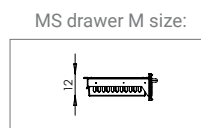
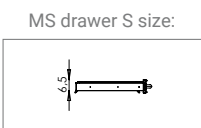

Don't you know how to select? We will be happy to advise you! Toll free: +420 800 100 798

MULTIFUNCTIONAL CARTS - MODULE SYSTEM

We can also assemble complete equipment for entire rooms. In addition to mobile products, we also offer fixed products, such as different types of racks, cabinets, stainless steel desks, countertops, sinks, shelves and other accessories.

For the areas, where material transferred in MS baskets is collected, we supply lockable dust-tight cabinets in three different heights with full or glassed doors.

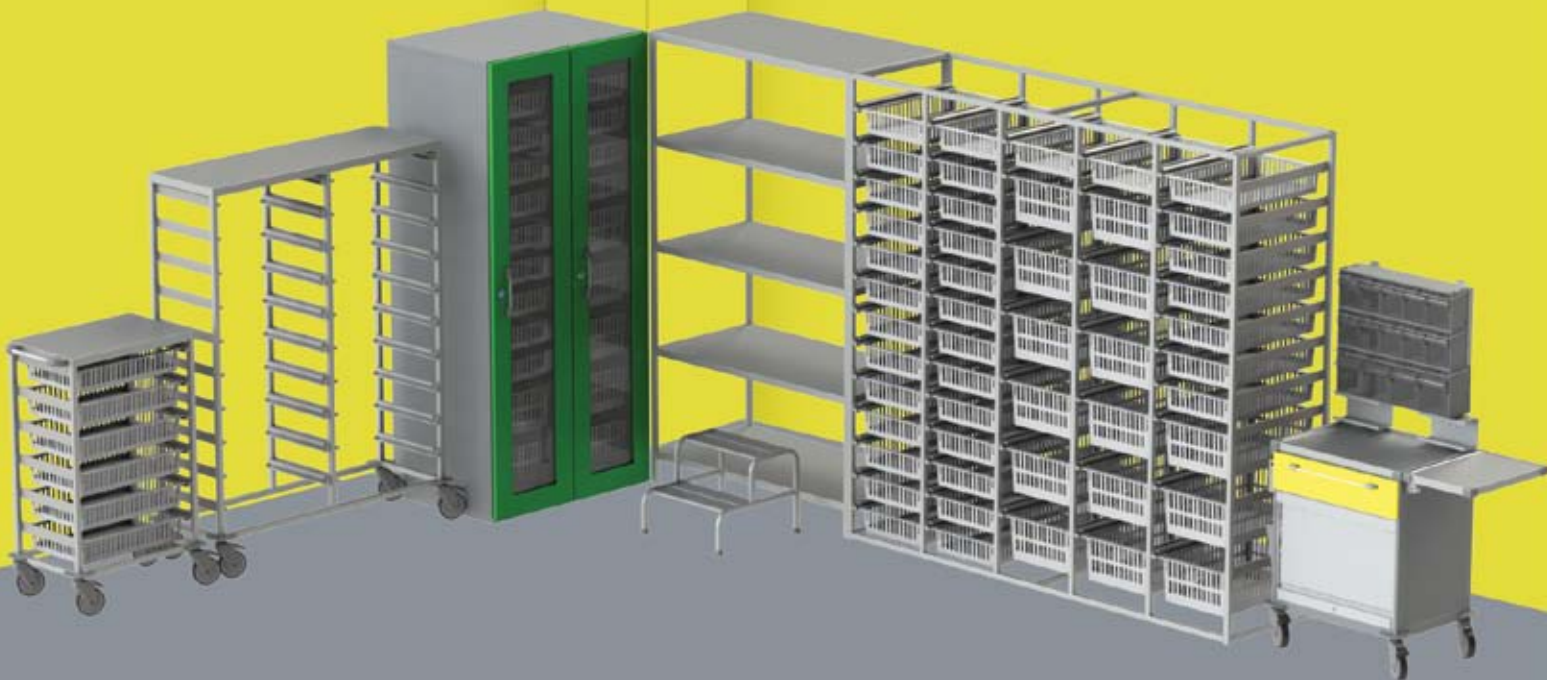

In addition to enclosed cabinets, the material in MS baskets can also be stored in open shelves of various sizes. Both types, open and closed, are equipped with rails for hanging differently deep MS baskets. Doors of cabinets, small cabinets etc. are supplied in different colours.

Therefore, the whole room can be colour matched according to your wishes.

We will be glad to specifically tailor the graphic design according to your requirements.

Don't you know how to select? We will be happy to advise you! Toll free: +420 800 100 798

MULTIFUNCTIONAL CARTS - MODULE SYSTEM

Our customers can choose from a copious number of types of carts and complements of a different design, sizes and a wide range of colours.

We monitor new trends, flexibly respond to more and more demanding requirements on quality, and we are continuously developing and proposing new improvements and new types of carts.

We don't leave any idea unnoticed. We collect new findings and experience from different types of facilities, and we use them to improve and design our products. Our development never ends.



Don't you know how to select? We will be happy to advise you! Toll free: +420 800 100 798

MULTIFUNCTIONAL CARTS - MODULE SYSTEM

METAL LINE PROFI - STANDARD

ROLLING SHUTTER CARTS

width 75 cm x depth 55 cm

LOW VERSION

(height 89 cm)

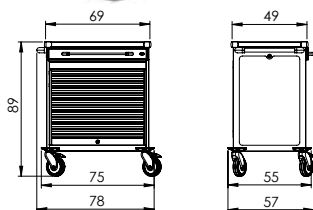

- carts with roller shutter ARE NOT standardly equipped with MS baskets
- select the number and sizes of baskets according to positions listed with each type of carts
- individual basket sizes can be arbitrarily combined with respect to the maximum number of positions.

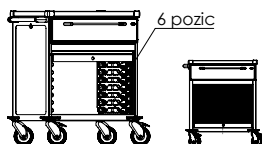

ZV1311N*

1x drawer M
6 positions

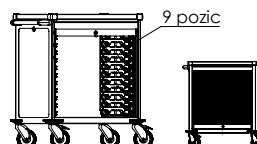

ZV1312N*

9 positions

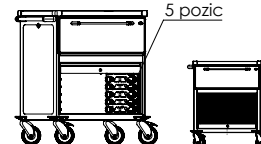

ZV1313N*

1x drawer L
5 positions

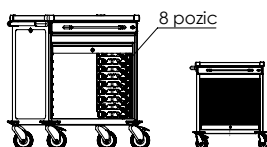

ZV1314N*

1x drawer S
8 positions

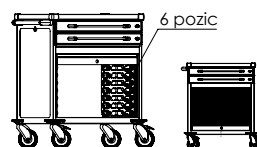

ZV1315N*

2x drawer S
6 positions

HIGH VERSION

(height 105 cm)

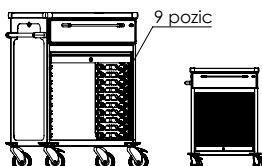
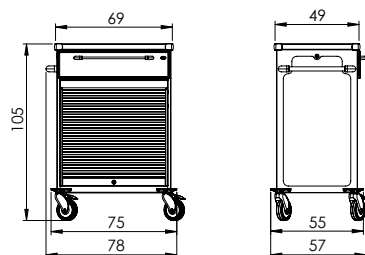

ZV1367N*

1x drawer M
9 positions

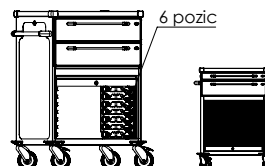

ZV1369N*

1x drawer S
1x drawer M
8 positions

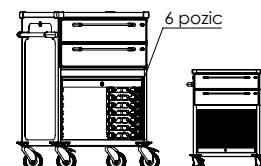

ZV1371N*

2x drawer M
6 positions

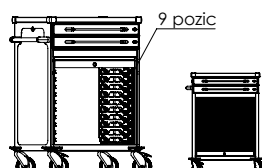

ZV1372N*

2x drawer S
9 positions

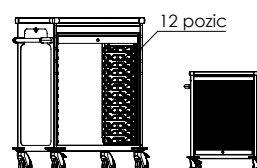

ZV1373N*

12 positions

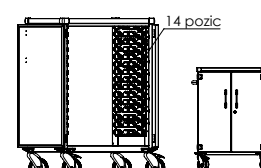

ZV1395N*

1x double door
14 positions

MS basket S size
(cat. No. 11419)
occupies 2 positions



MS basket M size
(cat. No. 11420)
occupies 3 positions



MS basket L size
(cat. No. 11421)
occupies 5 positions



Internal division of MS baskets, see p. 88.

Choose the variant of your cart according to the height of individual drawers:

MS drawer S size:

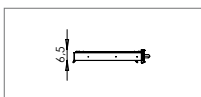

MS drawer M size:

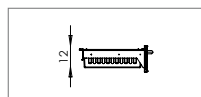

MS drawer L size:

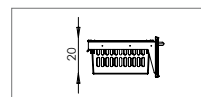

Don't you know how to select? We will be happy to advise you! Toll free: +420 800 100 798



MULTIFUNCTIONAL CARTS - MODULE SYSTEM

METAL LINE PROFI - STANDARD

DOCUMENTATION CARTS

width 78 cm x depth 65 cm

LOW VERSION

(height 92 cm)

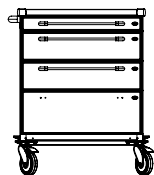
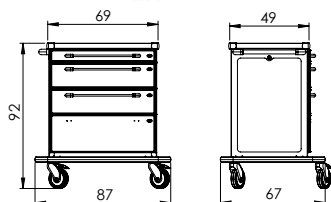

ZV1309N*

1x drawer S
1x drawer M
1x drawer XL
with divider

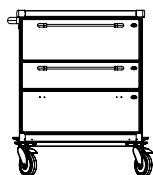

ZV1310N*

1x drawer L
1x drawer XL
with divider

HIGH VERSION

(height 108 / 105 cm)

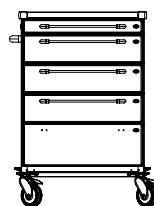
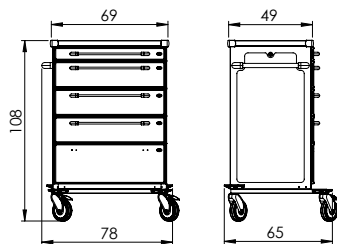

ZV1362N*

1x drawer S
2x drawer M
1x drawer XL
with divider

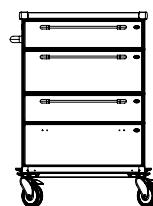

ZV1363N*

1x drawer M
1x drawer L
1x drawer XL
with divider

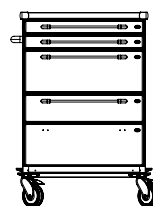

ZV1364N*

2x drawer S
1x drawer L
1x drawer XL
with divider

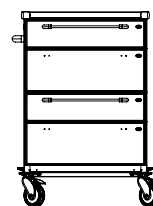

ZV1365N*

1x drawer XL
1x drawer XL
with divider

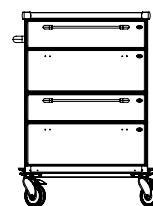

ZV1266N*

2x drawer XL
with divider

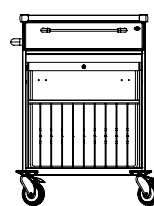

ZV1380N*

cart height: 105cm
1x drawer M
1x divider for
10 medical
documentation files

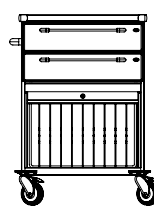
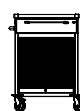

ZV1381N*

cart height: 105cm
2x drawer M
1x divider for
10 medical
documentation files

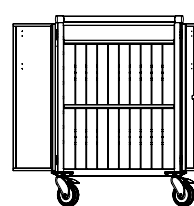

ZV1394N*

cart height: 105 cm
2x divider for
10 medical
documentation files



Detail of filing



MS drawer S size:

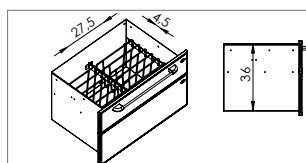
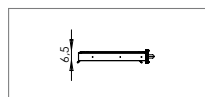

MS drawer M size:

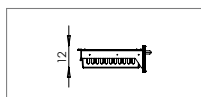

MS drawer L size:

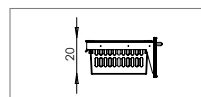

MS drawer XL size:

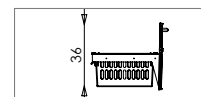

Steel drawer with divider for 16 medical documentation files. Partitions are removable to insert a larger documentation.

Internal division of MS baskets, see p. 88.

Choose the variant of your cart according to the height of individual drawers:

Don't you know how to select? We will be happy to advise you! Toll free: +420 800 100 798

MULTIFUNCTIONAL CARTS - MODULE SYSTEM

Carts can be equipped with drawers in a single or two rows next to each other or both types can be combined.

We offer drawers of four basic heights and different widths - with hinges for MS baskets or with fixed bottom or both variants can be used. In addition to MS baskets, drawers can be supplemented with partitions or dividers.

Drawers equipped with full telescopic ball sliding buffer and damper so they allow the MS basket to be easily pulled out, and they don't open during sliding.



Don't you know how to select? We will be happy to advise you! Toll free: +420 800 100 798

MULTIFUNCTIONAL CARTS - MODULE SYSTEM

METAL LINE PROFI - COMBI

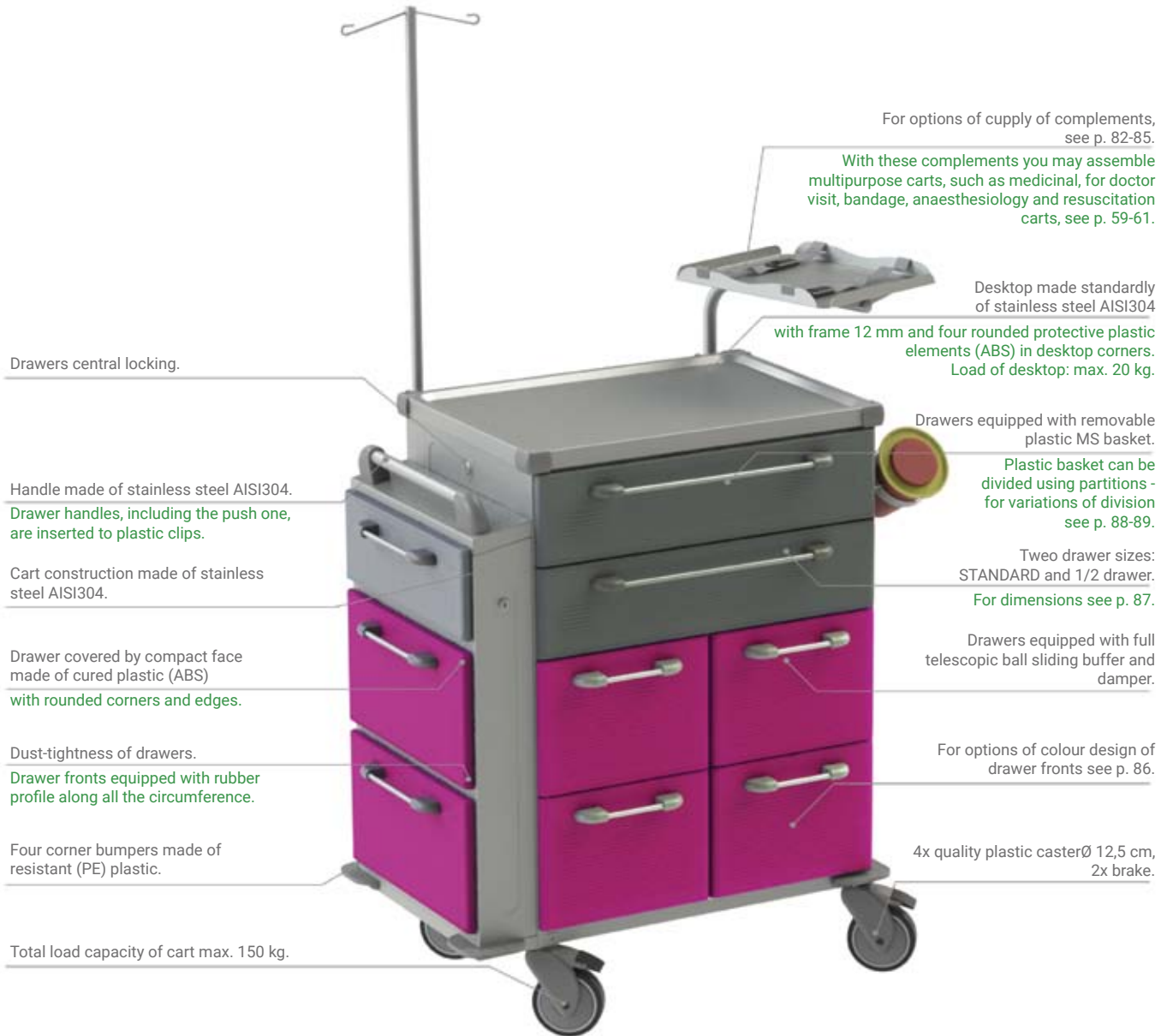

METAL LINE PROFI



Choose the variant of your cart according to the height of individual drawers:

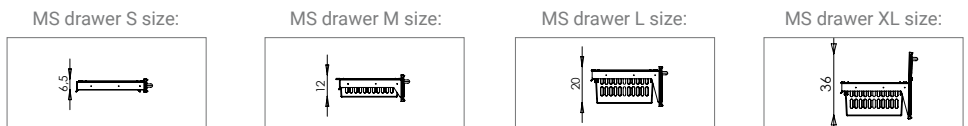

Internal division of MS baskets, see p. 88-89.

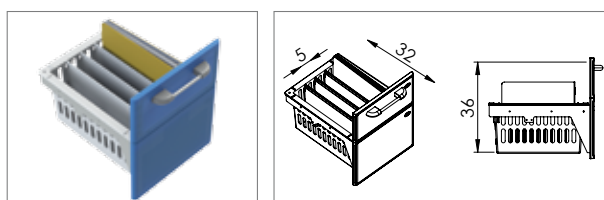

1/2 drawer with divider equipped with a plastic MS basket divided by removable partitions.

Don't you know how to select? We will be happy to advise you! Toll free: +420 800 100 798

MULTIFUNCTIONAL CARTS - MODULE SYSTEM

METAL LINE PROFI - COMBI

width 75 cm x depth 55 cm

LOW VERSION
(height 89 cm)

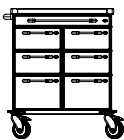
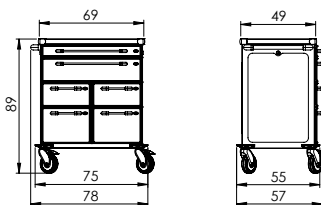

ZV2301N*

1x drawer S
4x 1/2 drawer M
2x 1/2 drawer L



ZV2302N*

1x drawer S
2x 1/2 drawer S
4x 1/2 drawer L



ZV2303N*

1x drawer S
2x 1/2 drawer S
6x 1/2 drawer M

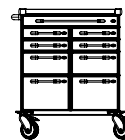

ZV2304N*

1x drawer S
4x 1/2 drawer S
2x 1/2 drawer M
2x 1/2 drawer L

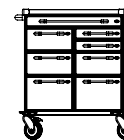

ZV2305N*

1x drawer S
2x 1/2 drawer S
3x 1/2 drawer M
2x 1/2 drawer L

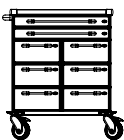

ZV2306N*

2x drawer S
6x 1/2 drawer M

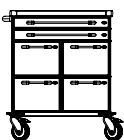

ZV2307N*

2x drawer S
4x 1/2 drawer L



ZV2308N*

2x drawer S
2x 1/2 drawer S
2x 1/2 drawer M
2x 1/2 drawer L

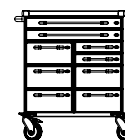

ZV2309N*

2x drawer S
2x 1/2 drawer S
5x 1/2 drawer M

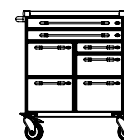

ZV2310N*

2x drawer S
1x 1/2 drawer S
1x 1/2 drawer M
3x 1/2 drawer L

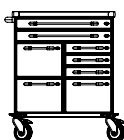

ZV2311N*

2x drawer S
3x 1/2 drawer S
3x 1/2 drawer L

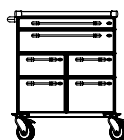

ZV2312N*

1x drawer S a M
2x 1/2 drawer M
2x 1/2 drawer L

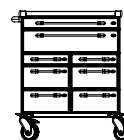

ZV2313N*

1x drawer S a M
2x 1/2 drawer S
4x 1/2 drawer M

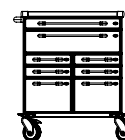

ZV2314N*

1x drawer S a M
4x 1/2 drawer S
2x 1/2 drawer L

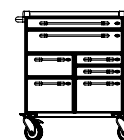

ZV2315N*

1x drawer S a M
2x 1/2 drawer S
1x 1/2 drawer M
2x 1/2 drawer L



ZV2316N*

1x drawer M
6x 1/2 drawer M

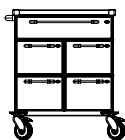

ZV2317N*

1x drawer M
4x 1/2 drawer L

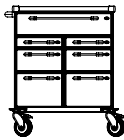

ZV2318N*

1x drawer M
2x 1/2 drawer S
2x 1/2 drawer M
2x 1/2 drawer L

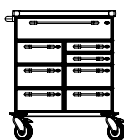

ZV2319N*

1x drawer M
2x 1/2 drawer S
5x 1/2 drawer M

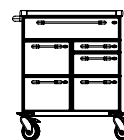

ZV2320N*

1x drawer M
1x 1/2 drawer S
1x 1/2 drawer M
3x 1/2 drawer L

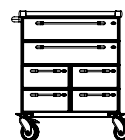

ZV2321N*

2x drawer M
4x 1/2 drawer M

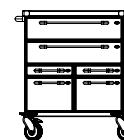

ZV2322N*

2x drawer M
2x 1/2 drawer S
2x 1/2 drawer L

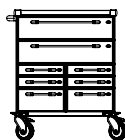

ZV2323N*

2x drawer M
4x 1/2 drawer S
2x 1/2 drawer M

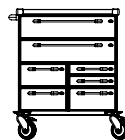

ZV2324N*

2x drawer M
2x 1/2 drawer S
3x 1/2 drawer M



ZV2325N*

1x drawer S a M
2x 1/2 drawer XL

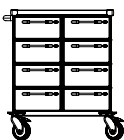

ZV2327N*

8x 1/2 drawer M

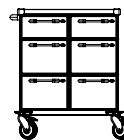

ZV2328N*

2x 1/2 drawer M
4x 1/2 drawer L

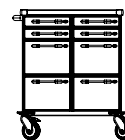

ZV2329N*

4x 1/2 drawer S
4x 1/2 drawer L



ZV2330N*

2x 1/2 drawer S
2x 1/2 drawer M
2x 1/2 drawer XL



ZV2331N*

2x 1/2 drawer L
2x 1/2 drawer XL

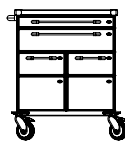

ZV2332N*

1x drawer S a M
2x 1/2 drawer XL
with divider

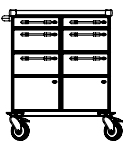

ZV2333N*

2x 1/2 drawer S
2x 1/2 drawer M
2x 1/2 drawer XL
with divider



ZV2334N*

2x 1/2 drawer L
2x 1/2 drawer XL
with divider

Don't you know how to select? We will be happy to advise you! Toll free: +420 800 100 798

MULTIFUNCTIONAL CARTS - MODULE SYSTEM

METAL LINE PROFI - COMBI

width 75 cm x depth 55 cm

HIGH VERSION

(height 105 cm)

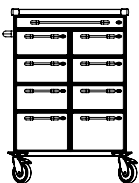
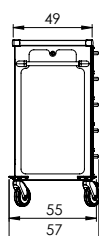
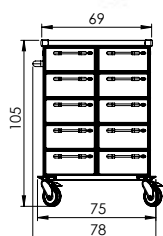

ZV2350N*

1x drawer S
6x 1/2 drawer M
2x 1/2 drawer L

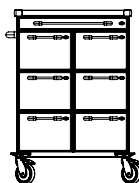

ZV2351N*

1x drawer S
6x 1/2 drawer L

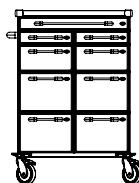

ZV2352N*

1x drawer S
2x 1/2 drawer S
2x 1/2 drawer M
4x 1/2 drawer L

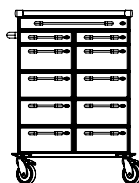

ZV2353N*

1x drawer S
2x 1/2 drawer S
8x 1/2 drawer M

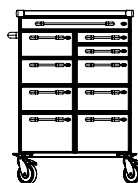

ZV2354N*

1x drawer S
2x 1/2 drawer S
5x 1/2 drawer M
2x 1/2 drawer L

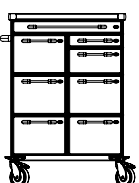

ZV2355N*

1x drawer S
1x 1/2 drawer S
1x 1/2 drawer M
5x 1/2 drawer L

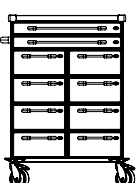

ZV2356N*

2x drawer S
8x 1/2 drawer M

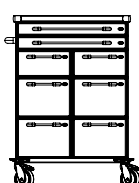

ZV2357N*

2x drawer S
2x 1/2 drawer M
4x 1/2 drawer L

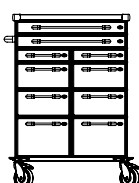

ZV2358N*

2x drawer S
2x 1/2 drawer S
4x 1/2 drawer M
2x 1/2 drawer L

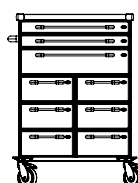

ZV2359N*

2x drawer S
1x drawer M
6x 1/2 drawer M

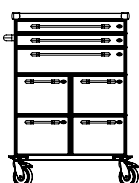

ZV2360N*

2x drawer S
1x drawer M
4x 1/2 drawer L

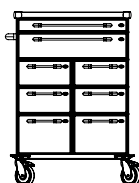

ZV2361N*

1x drawer S a M
4x 1/2 drawer M
2x 1/2 drawer L

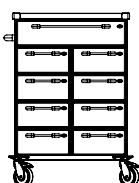

ZV2362N*

1x drawer M
8x 1/2 drawer M

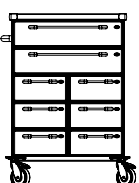

ZV2363N*

2x drawer M
6x 1/2 drawer M

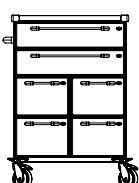

ZV2364N*

2x drawer M
4x 1/2 drawer L

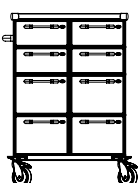

ZV2365N*

4x 1/2 drawer M
4x 1/2 drawer L

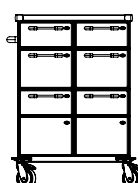

ZV2366N*

2x 1/2 drawer M
2x 1/2 drawer L
2x 1/2 drawer XL

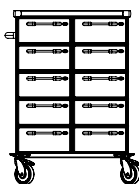

ZV2367N*

10x 1/2 drawer M

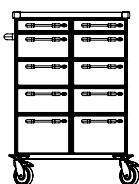

ZV2368N*

2x 1/2 drawer S
6x 1/2 drawer M
2x 1/2 drawer L

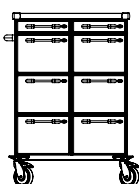

ZV2369N*

2x 1/2 drawer S
6x 1/2 drawer L

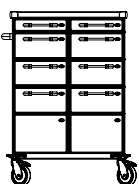

ZV2370N*

2x 1/2 drawer S
4x 1/2 drawer M
2x 1/2 drawer XL

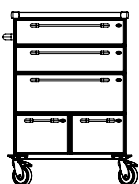

ZV2371N*

2x drawer M
1x drawer L
2x 1/2 drawer L

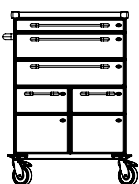

ZV2372N*

1x drawer S
2x drawer M
2x 1/2 drawer XL

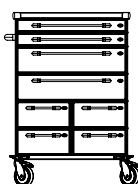

ZV2373N*

2x drawer S a M
4x 1/2 drawer M

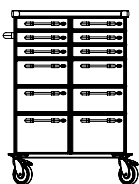

ZV2374N*

6x 1/2 drawer S
4x 1/2 drawer M
2x 1/2 drawer L

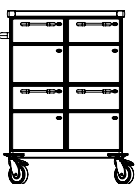

ZV2376N*

4x 1/2 drawer XL

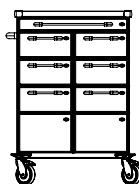

ZV2377N*

1x drawer S
4x 1/2 drawer M
2x 1/2 drawer XL

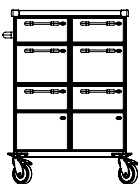

ZV2378N*

2x 1/2 drawer M
2x 1/2 drawer L
2x 1/2 drawer XL
with divider

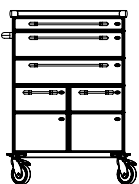

ZV2379N*

1x drawer S
2x drawer M
2x 1/2 drawer XL
with divider

Don't you know how to select? We will be happy to advise you! Toll free: +420 800 100 798

MULTIFUNCTIONAL CARTS - MODULE SYSTEM

METAL LINE PROFI - MAXI

For options of supply of complements, see p. 82-85.

With these complements you may assemble multipurpose cart, see p. 61.

Drawers central locking.

Handle made of stainless steel AISI304.

Drawer handles, including the push one, are inserted to plastic clips.

Cart construction made of stainless steel AISI304.

Drawer covered by compact face made of cured plastic (ABS) with rounded corners and edges.

Dust-tightness of drawers.

Drawer fronts equipped with rubber profile along all the circumference.

Four corner bumpers made of resistant (PE) plastic.

Total load capacity of cart max. 150 kg.

Desktop made standardly of stainless steel AISI304

with shallow depth and with four rounded plastic elements (ABS) in desktop corners.

Load of desktop: max. 20 kg.

Drawers equipped with removable plastic MS basket.

Plastic basket can be divided using partitions - for variations of division see p. 89.

3/4 drawer size.

For dimensions see p. 87.

Drawers equipped with full telescopic ball sliding buffer and damper.

For options of colour design of drawer fronts see p. 86.

4x quality plastic caster \varnothing 12,5 cm, 2x brake.



Choose the variant of your cart according to the height of individual drawers:

MS drawer S size:

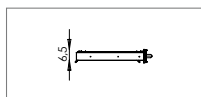

MS drawer M size:

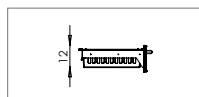

MS drawer L size:

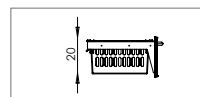

MS drawer XL size:

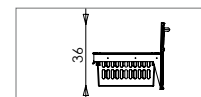

Internal division of MS baskets, see p. 89.

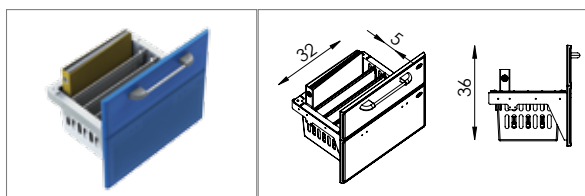

3/4 drawer with divider equipped with a plastic MS basket divided by removable partitions.



Don't you know how to select? We will be happy to advise you! Toll free: +420 800 100 798

MULTIFUNCTIONAL CARTS - MODULE SYSTEM

METAL LINE PROFI - MAXI

width 102 cm x depth 50 cm

LOW VERSION
(height 89 cm)

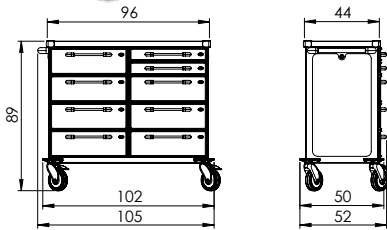

HIGH VERSION
(height 105 cm)

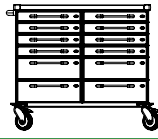
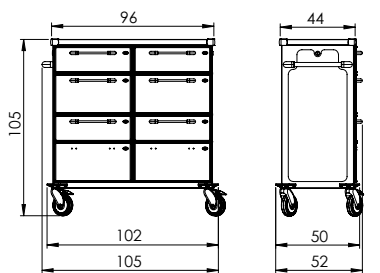

ZV4301N*

8x 3/4 drawer S
4x 3/4 drawer M

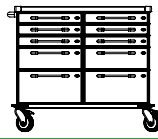

ZV4302N*

6x 3/4 drawer S
2x 3/4 drawer M
2x 3/4 drawer L

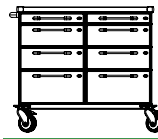

ZV4303N*

2x 3/4 drawer S
4x 3/4 drawer M
2x 3/4 drawer L

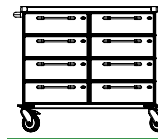

ZV4304N*

8x 3/4 drawer M

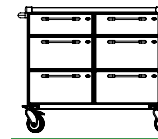

ZV4305N*

2x 3/4 drawer M
4x 3/4 drawer L

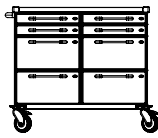

ZV4306N*

4x 3/4 drawer S
4x 3/4 drawer L



ZV4308N*

2x 3/4 drawer L
2x 3/4 drawer XL

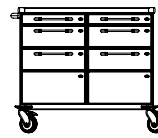

ZV4309N*

2x 3/4 drawer S
2x 3/4 drawer M
2x 3/4 drawer XL

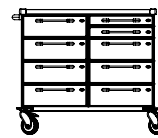

ZV4311N*

7x 3/4 drawer M
2x 3/4 drawer S

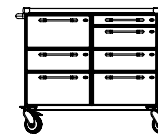

ZV4312N*

1x 3/4 drawer S
3x 3/4 drawer M
3x 3/4 drawer L



ZV4313N*

2x 3/4 drawer L
2x 3/4 drawer XL
with divider



ZV4314N*

2x 3/4 drawer S
2x 3/4 drawer M
2x 3/4 drawer XL
with divider

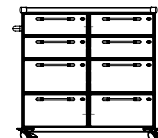

ZV4351N*

4x 3/4 drawer M
4x 3/4 drawer L

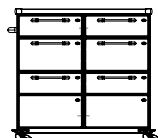

ZV4352N*

2x 3/4 drawer M
2x 3/4 drawer L
2x 3/4 drawer XL

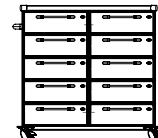

ZV4353N*

10x 3/4 drawer M

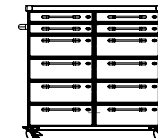

ZV4354N*

4x 3/4 drawer S
8x 3/4 drawer M

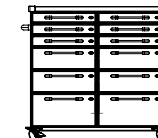

ZV4355N*

6x 3/4 drawer S
4x 3/4 drawer M
2x 3/4 drawer L

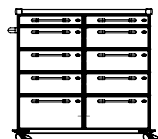

ZV4356N*

2x 3/4 drawer S
6x 3/4 drawer M
2x 3/4 drawer L

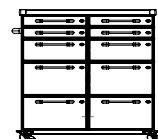

ZV4357N*

4x 3/4 drawer S
2x 3/4 drawer M
4x 3/4 drawer L

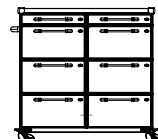

ZV4358N*

2x 3/4 drawer S
6x 3/4 drawer L

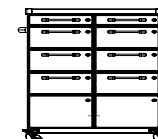

ZV4359N*

2x 3/4 drawer S
4x 3/4 drawer M
2x 3/4 drawer XL

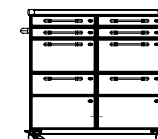

ZV4360N*

4x 3/4 drawer S
2x 3/4 drawer L
2x 3/4 drawer XL

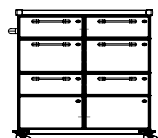

ZV4361N*

2x 3/4 drawer M
2x 3/4 drawer L
2x 3/4 drawer XL
with divider

MULTIFUNCTIONAL CARTS - MODULE SYSTEM

Lockable fixed door with right and left lock, with transparent or full door for deposit of MS baskets of various sizes and colour matched carts with optional height of drawers.

All this complemented by fixed stainless steel desk.

Choose colours from our catalogue of colours.



Don't you know how to select? We will be happy to advise you! Toll free: +420 800 100 798

MULTIFUNCTIONAL CARTS - MODULE SYSTEM

METAL LINE PROFI - MINI

For options of supply of complements, see p. 82-85.

With these complements you may assemble multipurpose carts, see p. 61.

Handles made of stainless steel AISI304.

Drawer handles, including the push one, are inserted to plastic clips.

Cart construction made of stainless steel AISI304.

Drawers central locking.

Drawer covered by compact face made of cured plastic (ABS) with rounded corners and edges.

Dust-tightness of drawers. Drawer fronts equipped with rubber profile along all the circumference.

Drawers equipped with removable plastic MS basket.

Plastic basket can be divided using partitions - for variations of division see p. 89.

Four corner bumpers made of resistant (PE) plastic.

Total load capacity of cart max. 150 kg.

Desktop made standardly of stainless steel AISI304

with shallow depth and with four rounded plastic elements (ABS) in desktop corners. Load of desktop: max. 20 kg.

3/4 drawer size.

For dimensions see p. 87.

Drawers equipped with full telescopic ball sliding buffer and damper.

For options of colour design of drawer fronts see p. 86.

4x quality plastic caster Ø 12,5 cm, 2x brake.



Choose the variant of your cart according to the height of individual drawers:

MS drawer S size:

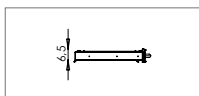

MS drawer M size:

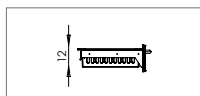

MS drawer L size:

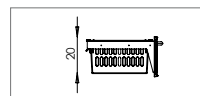

MS drawer XL size:

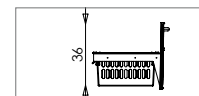

Internal division of MS baskets, see p. 89.

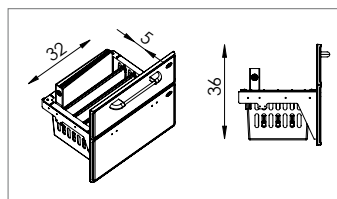

3/4 drawer with divider equipped with a plastic MS basket divided by removable partitions.

Don't you know how to select? We will be happy to advise you! Toll free: +420 800 100 798

MULTIFUNCTIONAL CARTS - MODULE SYSTEM

METAL LINE PROFI - MINI

width 55 cm x depth 50 cm

LOW VERSION

(height 89 cm)

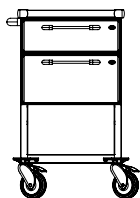
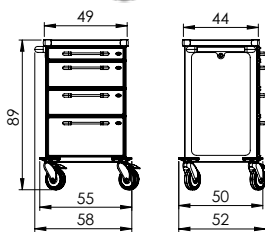

ZV3300N*
1x 3/4 drawer M
1x 3/4 drawer L
1x fixed shelf (bottom)

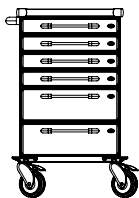

ZV3301N*
4x 3/4 drawer S
2x 3/4 drawer M

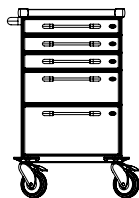

ZV3302N*
3x 3/4 drawer S
1x 3/4 drawer M
1x 3/4 drawer L

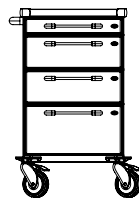

ZV3303N*
1x 3/4 drawer S
2x 3/4 drawer M
1x 3/4 drawer L

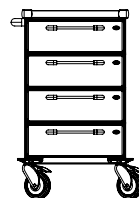

ZV3304N*
4x 3/4 drawer M

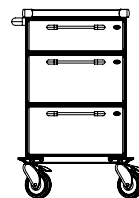

ZV3305N*
1x 3/4 drawer M
2x 3/4 drawer L

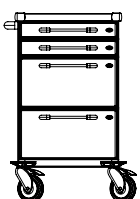

ZV3306N*
2x 3/4 drawer S
2x 3/4 drawer L

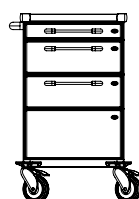

ZV3307N*
1x 3/4 drawer S
1x 3/4 drawer M
1x 3/4 drawer XL

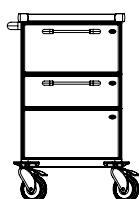

ZV3308N*
1x 3/4 drawer L
1x 3/4 drawer XL

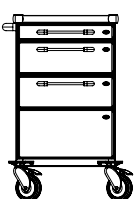

ZV3309N*
1x 3/4 drawer S
1x 3/4 drawer M
1x 3/4 drawer XL
with divider

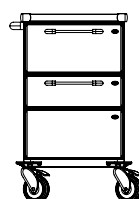

ZV3310N*
1x 3/4 drawer L
1x 3/4 drawer XL
with divider

HIGH VERSION

(height 105 cm)

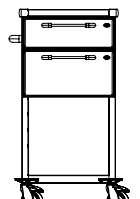
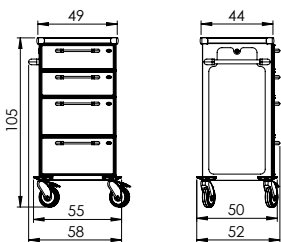

ZV3350N*
1x 3/4 drawer M
1x 3/4 drawer L
1x fixed shelf (bottom)

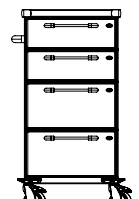

ZV3351N*
2x 3/4 drawer M
2x 3/4 drawer L

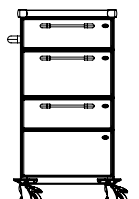

ZV3352N*
1x 3/4 drawer M
1x 3/4 drawer L
1x 3/4 drawer XL

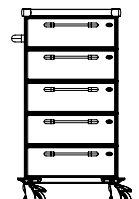

ZV3353N*
5x 3/4 drawer M

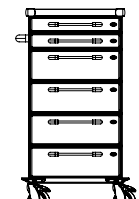

ZV3354N*
2x 3/4 drawer S
4x 3/4 drawer M

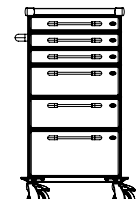

ZV3355N*
3x 3/4 drawer S
2x 3/4 drawer M
1x 3/4 drawer L

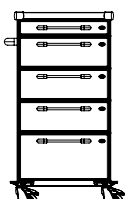

ZV3356N*
1x 3/4 drawer S
3x 3/4 drawer M
1x 3/4 drawer L

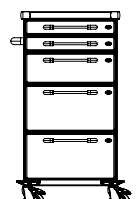

ZV3357N*
2x 3/4 drawer S
1x 3/4 drawer M
2x 3/4 drawer L

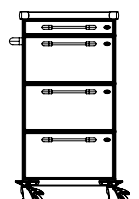

ZV3358N*
1x 3/4 drawer S
3x 3/4 drawer L

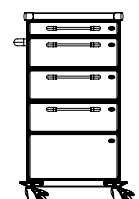

ZV3359N*
1x 3/4 drawer S
2x 3/4 drawer M
1x 3/4 drawer XL

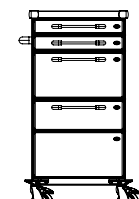

ZV3360N*
2x 3/4 drawer S
1x 3/4 drawer L
1x 3/4 drawer XL

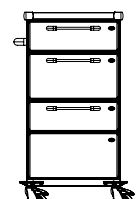

ZV3363N*
1x 3/4 drawer M
1x 3/4 drawer L
1x 3/4 drawer XL
with divider

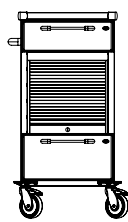

ZV3370N*
1x lockable roller shutter
1x 3/4 drawer M
1x 3/4 drawer L
2x fixed shelf

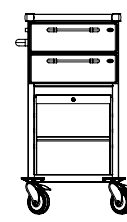

ZV3371N*
1x lockable roller shutter
2x 3/4 drawer M
2x fixed shelf

Don't you know how to select? We will be happy to advise you! Toll free: +420 800 100 798

MULTIFUNCTIONAL CARTS - MODULE SYSTEM

SO MANY DRAWERS,
MANY THINGS
CAN GET IN!



Another example of the room equipment: another arrangement of fixed cabinets to insert MS baskets and stainless steel desk complemented by handling carts of various types.



Don't you know how to select? We will be happy to advise you! Toll free: +420 800 100 798

MULTIFUNCTIONAL CARTS - MODULE SYSTEM

METAL LINE PROFI - PICCOLO

width 41 cm x depth 55 cm



Drawers central locking.

Handles made of stainless steel AISI304.

Drawer handles are inserted to plastic clips.

Cart construction made of stainless steel AISI304.

Drawer covered by compact face made of cured plastic (ABS) with rounded corners and edges.

Dust-tightness of drawers.

Drawer fronts equipped with rubber profile along all the circumference.

Four corner bumpers made of resistant (PE) plastic.

Total load capacity of cart max. 100 kg.

Desktop made standardly of stainless steel AISI304.

with shallow depth and four curved plastic elements (ABS) in desktop corners. Load of desktop: max. 20 kg.

Drawers equipped with removable plastic MS baskets.

Plastic basket can be divided using partitions - for variations of division see p. 89.

For options of colour design of drawer fronts see p. 85.

Drawers equipped with full telescopic ball sliding buffer and damper.

1/2 drawer size.

For dimensions see p. 87.

4x quality plastic caster Ø 12,5 cm, 2x brake.

LOW VERSION ONLY: (height 89 cm)

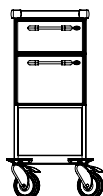
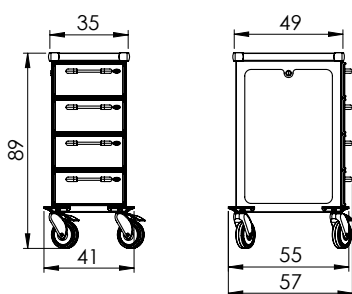

ZV5300N*

1x 1/2 drawer M
1x 1/2 drawer L
1x fixed shelf (bottom)

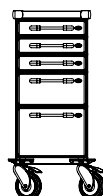

ZV5302N*

3x 1/2 drawer S
1x 1/2 drawer M
1x 1/2 drawer L

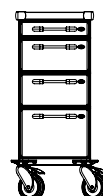

ZV5303N*

1x 1/2 drawer S
2x 1/2 drawer M
1x 1/2 drawer L

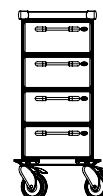

ZV5304N*

4x 1/2 drawer M



ZV5305N*

1x 1/2 drawer M
2x 1/2 drawer L

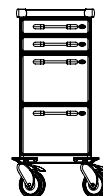

ZV5306N*

2x 1/2 drawer S
2x 1/2 drawer L

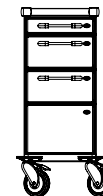

ZV5307N*

1x 1/2 drawer S
1x 1/2 drawer M
1x 1/2 drawer XL

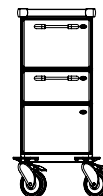

ZV5308N*

1x 1/2 drawer L
1x 1/2 drawer XL

Internal division of MS baskets, see p. 89.

Choose the variant of your cart according to the height of individual drawers:

MS drawer S size:

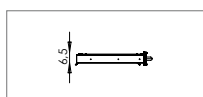

MS drawer M size:

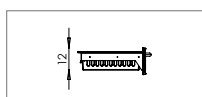

MS drawer L size:

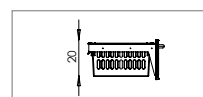

MS drawer XL size:

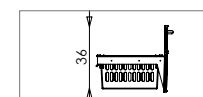

Don't you know how to select? We will be happy to advise you! Toll free: +420 800 100 798

MULTIFUNCTIONAL CARTS - MODULE SYSTEM

METAL LINE BASIC/PROFI - CABINET, ROLLER SHUTTER CARTS

WITH SHELVES - DUST-TIGHT

width 75 cm x depth 55 cm

LOW VERSION

(height 89 cm)

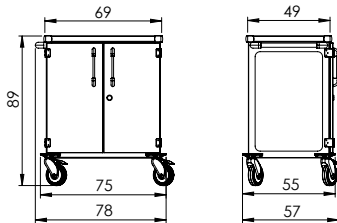

BASIC – construction made of steel with powder coating

PROFI – construction made of stainless steel AISI304

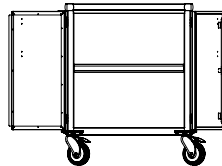

BASIC
PROFI

ZV1224N*

ZV1324N*

2x fixed shelf

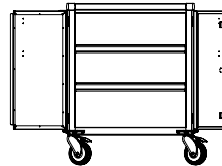

ZV1225N*

ZV1325N*

3x fixed shelf

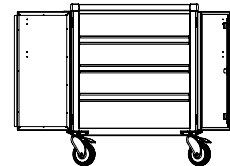

ZV1221N*

ZV1321N*

4x fixed shelf



Detail of the maximum door opening:

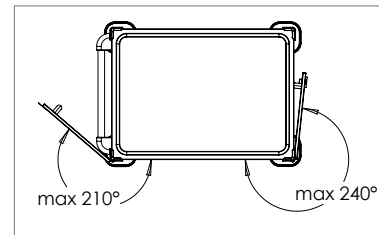

HIGH VERSION

(height 105 cm)

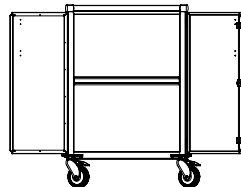
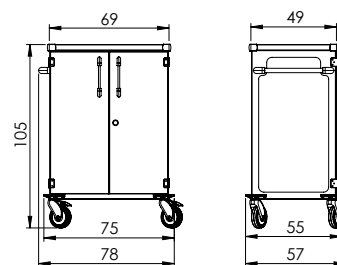

BASIC
PROFI

ZV1291N*

ZV1391N*

2x fixed shelf

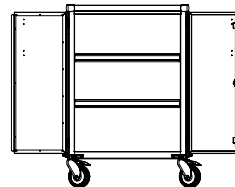

ZV1292N*

ZV1392N*

3x fixed shelf

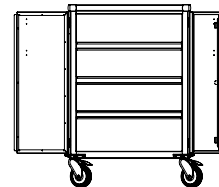

ZV1293N*

ZV1393N*

4x fixed shelf

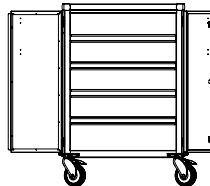

BASIC
PROFI

ZV1277N*

ZV1377N*

5x fixed shelf



ZV1290N*

ZV1390N*

2x fixed shelf
1x lockable ABS roller shutter



MULTIFUNCTIONAL CARTS - MODULE SYSTEM

FOR VARIOUS OPERATIONS

In addition to universal types of carts used in various operations, we offer also very specific carts developed for different departments.

Carts can be equipped with the barrier or with plastic desktop with the barrier.



Using various complements you can create carts, such as medicinal, bandage, doctor visit, resuscitation, surgical and other carts for specific activities.

Don't you know how to select? We will be happy to advise you! Toll free: +420 800 100 798

MULTIFUNCTIONAL CARTS - MODULE SYSTEM

MEDICINAL CARTS

LOW VERSION



HIGH VERSION



BANDAGE CARTS

LOW VERSION



HIGH VERSION



Don't you know how to select? We will be happy to advise you! Toll free: +420 800 100 798

MULTIFUNCTIONAL CARTS - MODULE SYSTEM

ANESTHESIOLOGY CARTS

LOW VERSION



HIGH VERSION



RESUSCITATION CARTS

LOW VERSION



HIGH VERSION



DOCTOR VISIT CARTS

LOW VERSION



HIGH VERSION



Don't you know how to select? We will be happy to advise you! Toll free: +420 800 100 798

MULTIFUNCTIONAL CARTS - MODULE SYSTEM

MEDICINAL CARTS LOW VERSION



RESUSCITATION CARTS HIGH VERSION



MEDICINAL CARTS LOW VERSION



HIGH VERSION



TYPE CARTS WITH COMPLEMENTS - MINI LINE

LOW VERSION



HIGH VERSION



Don't you know how to select? We will be happy to advise you! Toll free: +420 800 100 798

MULTIFUNCTIONAL CARTS

We know how to fit our offer to your space and operation and to your financial options.

Our goal is to make your work easier and of better quality.

We offer most complex selection of handling technology products on the Czech market.

Basic cart versions can be complemented by various complements that can be interchanged according to the actual need.



Don't you know how to select? We will be happy to advise you! Toll free: +420 800 100 798

MULTIFUNCTIONAL CARTS - WITHOUT MODULE SYSTEM

METAL LINE ECO - STANDARD DRAWER CARTS

For options of supply of complements, see p. 82-85.
With these complements you may assemble multi-purpose carts, such as medicinal, doctor visit, bandage, anaesthesiology and resuscitation.

Desktop made standardly of stainless steel AISI304
with frame 12 mm and four rounded protective plastic elements (ABS) in desktop corners.
Load of desktop: max. 20 kg.

Drawers central locking.

Steel handle with powder coating RAL7042, colour grey.
Drawer handles, including the push one, are inserted to plastic clips.

Cart construction made of steel with powder coating grey RAL7042.

Drawer covered by compact face made of cured plastic (ABS) with rounded corners and edges.

Steel drawer with powder coating RAL7042, colour grey.

Drawers equipped with full telescopic ball sliding buffer and damper.

For options of colour design of drawer fronts see p. 86.

4x quality galvanized caster Ø 10 cm, 2x brake.

Four round plastic bumpers.

Total load capacity of cart max. 150 kg.

OPEN CARTS, CARTS WITH ROLLER SHUTTER, DOCUMENTATION CARTS

Bottom shelf in ECO line made of steel with powder coating RAL7042, colour grey.

Lockable plastic (ABS) roller shutter.

Drawer with divider for 11 medical documentation files.

Don't you know how to select? We will be happy to advise you! Toll free: +420 800 100 798

MULTIFUNCTIONAL CARTS - WITHOUT MODULE SYSTEM

METAL LINE ECO - STANDARD

DRAWER CARTS

width 75 cm x depth 55 cm

LOW VERSION

(height 86 cm)

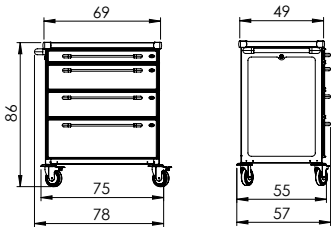

HIGH VERSION

(height 102 cm)

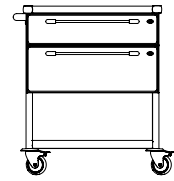
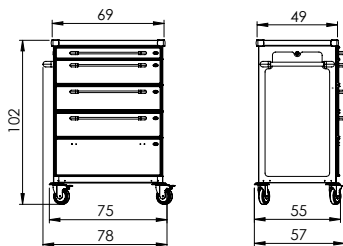

ZV1100N*
1x drawer M
1x drawer L
1x fixed shelf (bottom)

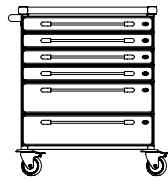

ZV1101N*
4x drawer S
2x drawer M

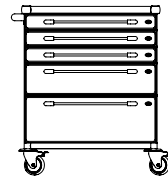

ZV1102N*
3x drawer S
1x drawer M
1x drawer L

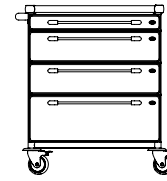

ZV1103N*
1x drawer S
2x drawer M
1x drawer L

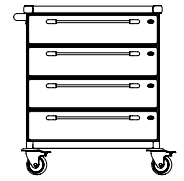

ZV1104N*
4x drawer M

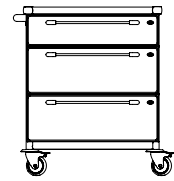

ZV1105N*
1x drawer M
2x drawer L

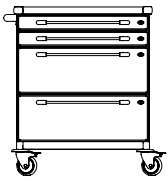

ZV1106N*
2x drawer S
2x drawer L

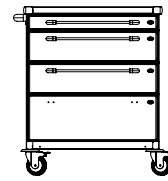

ZV1107N*
1x drawer S
1x drawer M
1x drawer XL

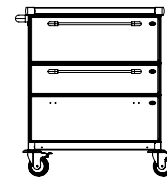

ZV1108N*
1x drawer L
1x drawer XL

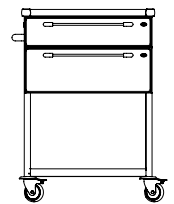

ZV1150N*
1x drawer M
1x drawer L
1x fixed shelf (bottom)

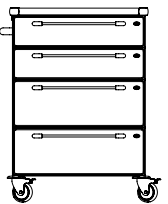

ZV1151N*
2x drawer M
2x drawer L

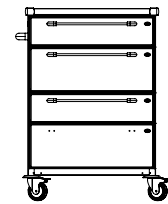

ZV1152N*
1x drawer M
1x drawer L
1x drawer XL

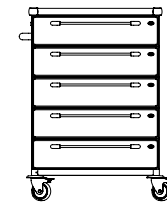

ZV1153N*
5x drawer M

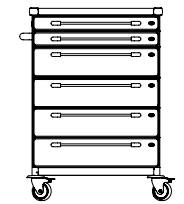

ZV1154N*
2x drawer S
4x drawer M

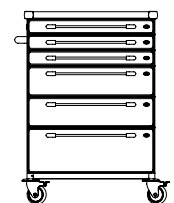

ZV1155N*
3x drawer S
2x drawer M
1x drawer L

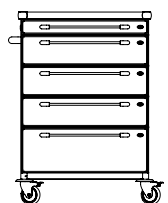

ZV1156N*
1x drawer S
3x drawer M
1x drawer L

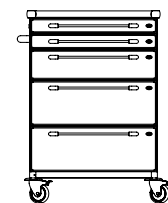

ZV1157N*
2x drawer S
1x drawer M
2x drawer L

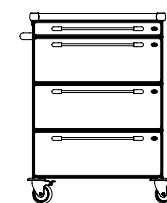

ZV1158N*
1x drawer S
3x drawer L

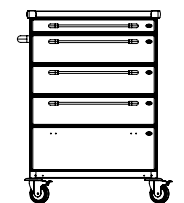

ZV1159N*
1x drawer S
2x drawer M
1x drawer L

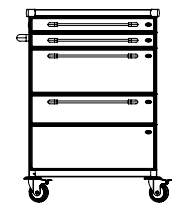

ZV1160N*
2x drawer S
1x drawer L
1x drawer XL

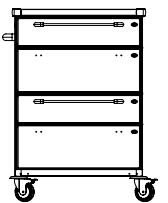

ZV1161N*
2x drawer XL

Steel drawer S size:

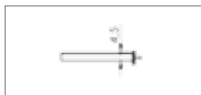

Steel drawer M size:

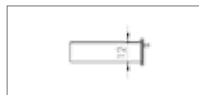

Steel drawer L size:

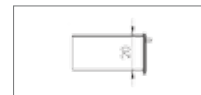

Steel drawer XL size:



Choose the variant of your cart according to the height of individual drawers:

Don't you know how to select? We will be happy to advise you! Toll free: +420 800 100 798

MULTIFUNCTIONAL CARTS - WITHOUT MODULE SYSTEM

METAL LINE ECO - STANDARD OPEN

width 75 cm x depth 55 cm

HIGH VERSION ONLY
(height 102 cm)

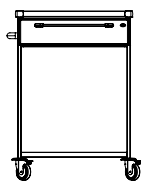
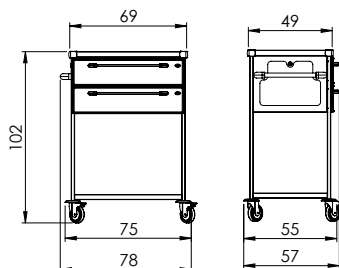

ZV1190N*
1x drawer M
1x bottom shelf

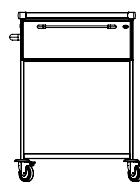

ZV1191N*
1x drawer L
1x bottom shelf

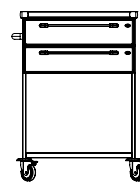

ZV1192N*
2x drawer M
1x bottom shelf

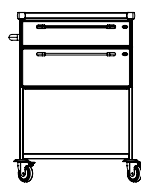

ZV1193N*
1x drawer M
1x drawer L
1x bottom shelf

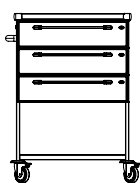

ZV1194N*
3x drawer M
1x bottom shelf

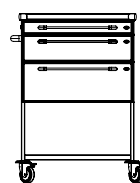

ZV1195N*
1x drawer S
1x drawer M
1x drawer L
1x bottom shelf



Choose the variant of your cart according to the height of individual drawers:

Steel drawer S size:

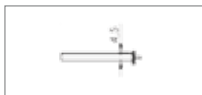

Steel drawer M size:

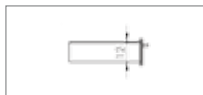

Steel drawer L size:

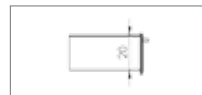

Don't you know how to select? We will be happy to advise you! Toll free: +420 800 100 798

MULTIFUNCTIONAL CARTS WITHOUT MODULE SYSTEM

We produce all the carts in two basic height variants and in different widths and lengths so that they can be incorporated into the existing equipment of medical rooms, patient wards and other operations and adapted to the fixed room equipment in colour and dimensions.

It is only upon you which types you choose and assemble. We will satisfy your requirements and preferences.



Don't you know how to select? We will be happy to advise you! Toll free: +420 800 100 798

MULTIFUNCTIONAL CARTS - WITHOUT MODULE SYSTEM

METAL LINE ECO - STANDARD

ROLLING SHUTTER

CARTS

width 75 cm x depth 55 cm

LOW VERSION

(height 86 cm)

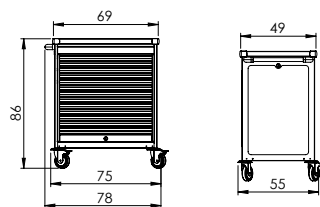

- carts with roller shutter ARE NOT standardly equipped with MS baskets
- select the number and sizes of baskets according to positions listed with each type of carts
- individual basket sizes can be arbitrarily combined with respect to the maximum number of positions

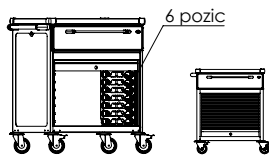

ZV1111N*
1x drawer M
6 positions

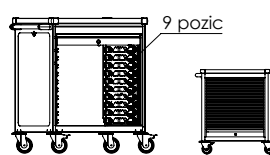

ZV1112N*
9 positions

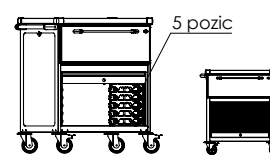

ZV1113N*
1x drawer L
5 positions

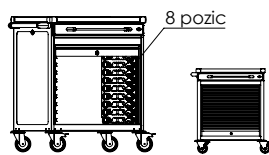

ZV1114N*
1x drawer S
8 positions

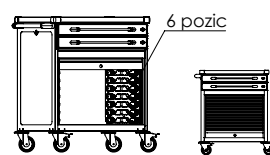

ZV1115N*
2x drawer S
6 positions

HIGH VERSION

(height 102 cm)

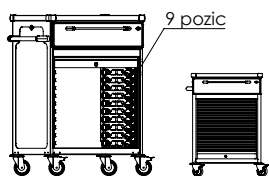
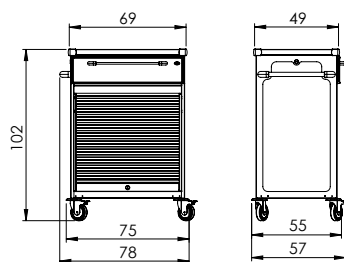

ZV1167N*
1x drawer M
9 positions

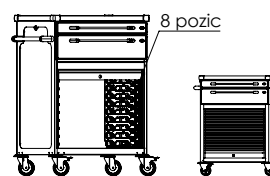

ZV1169N*
1x drawer S
1x drawer M
8 positions

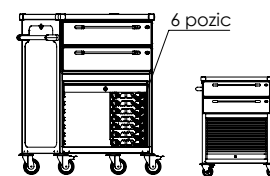

ZV1171N*
2x drawer M
6 positions

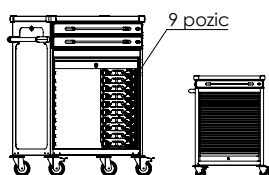

ZV1172N*
2x drawer S
9 positions

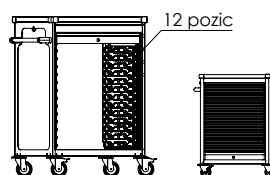

ZV1173N*
12 positions

MS basket S size
(cat. No. 11419)
occupies 2 positions



MS basket M size
(cat. No. 11420)
occupies 3 positions



MS basket L size
(cat. No. 11421)
occupies 5 positions



Internal division of MS baskets, see p. 88.

Choose the variant of your cart according to the height of individual drawers:

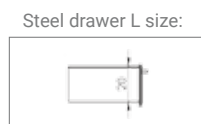
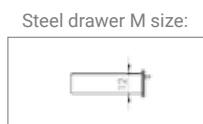
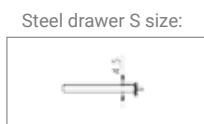

Don't you know how to select? We will be happy to advise you! Toll free: +420 800 100 798

MULTIFUNCTIONAL CARTS - WITHOUT MODULE SYSTEM

METAL LINE ECO - STANDARD

DOCUMENTATION CARTS
width 75 cm x depth 55 cm

LOW VERSION
(height 86 cm)

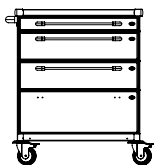
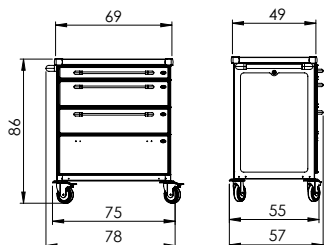

ZV1109N*
1x drawer S
1x drawer M
1x drawer XL
with divider

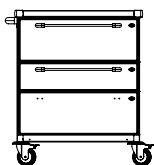

ZV1110N*
1x drawer L
1x drawer XL
with divider

HIGH VERSION
(height 102 cm)

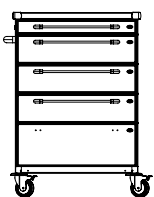
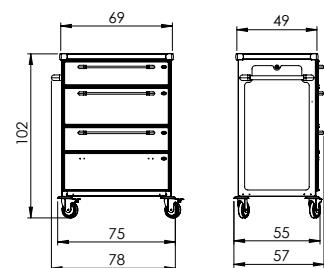

ZV1162N*
1x drawer S
2x drawer M
1x drawer XL
with divider

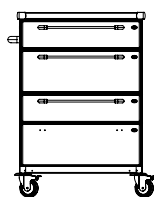

ZV1163N*
1x drawer M
1x drawer L
1x drawer XL
with divider

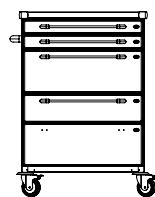

ZV1164N*
2x drawer S
1x drawer L
1x drawer X
with divider

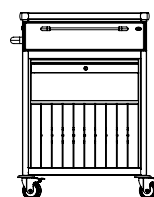

ZV1180N*
1x drawer M
1x divider for 10
medical
documentation files

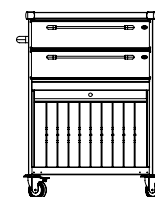
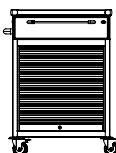

ZV1181N*
2x drawer M
1x divider for 10
medical
documentation files

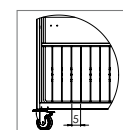
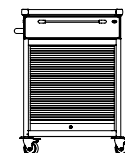

Divider detail:



Steel drawer S size:

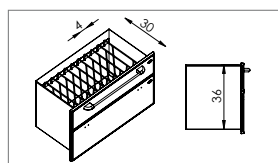
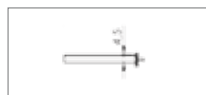

Steel drawer M size:

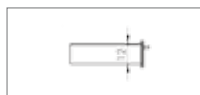

Drawer with divider for 11 medical documentation files. Partitions can be pulled out to insert a larger documentation.

Steel drawer L size:

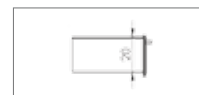

Choose the variant of your cart according to the height of individual drawers:

Don't you know how to select? We will be happy to advise you! Toll free: +420 800 100 798



METAL LINE ECO

MULTIFUNCTIONAL CARTS - WITHOUT MODULE SYSTEM

METAL LINE ECO - COMBI



Choose the variant of your cart according to the height of individual drawers:

Steel drawer S size:

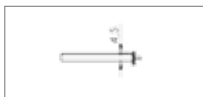

Steel drawer M size:

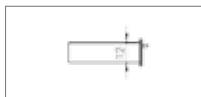

Steel drawer L size:

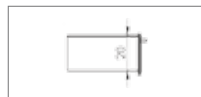

Steel drawer XL size:

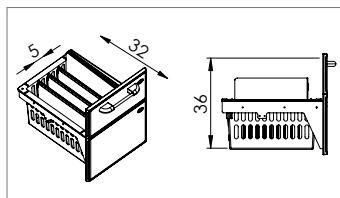

1/2 drawer with divider equipped with plastic MS basket divided by removable partitions.

Don't you know how to select? We will be happy to advise you! Toll free: +420 800 100 798

MULTIFUNCTIONAL CARTS - WITHOUT MODULE SYSTEM

METAL LINE ECO - COMBI

width 75 cm x depth 55 cm

LOW VERSION

(height 86 cm)

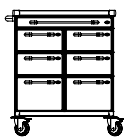
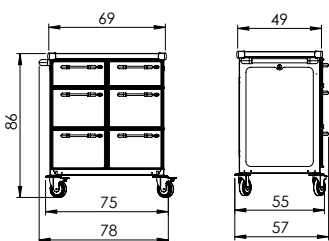

ZV2101N*
1x drawer S
4x 1/2 drawer M
2x 1/2 drawer L

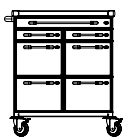

ZV2102N*
1x drawer S
2x 1/2 drawer S
4x 1/2 drawer L

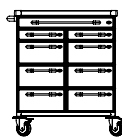

ZV2103N*
1x drawer S
2x 1/2 drawer S
6x 1/2 drawer M

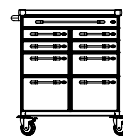

ZV2104N*
1x drawer S
4x 1/2 drawer S
2x 1/2 drawer M
2x 1/2 drawer L

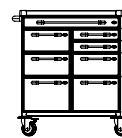

ZV2105N*
1x drawer S
2x 1/2 drawer S
3x 1/2 drawer M
2x 1/2 drawer L

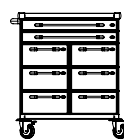

ZV2106N*
2x drawer S
6x 1/2 drawer M

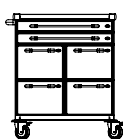

ZV2107N*
2x drawer S
4x 1/2 drawer L

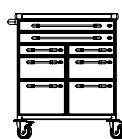

ZV2108N*
2x drawer S
2x 1/2 drawer S
2x 1/2 drawer M
2x 1/2 drawer L

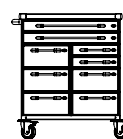

ZV2109N*
2x drawer S
2x 1/2 drawer S
5x 1/2 drawer M

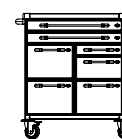

ZV2110N*
2x drawer S
1x 1/2 drawer S
1x 1/2 drawer M
3x 1/2 drawer L

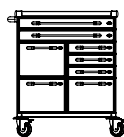

ZV2111N*
2x drawer S
3x 1/2 drawer S
3x 1/2 drawer L

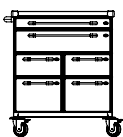

ZV2112N*
1x drawer S a M
2x 1/2 drawer M
2x 1/2 drawer L

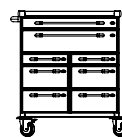

ZV2113N*
1x drawer S a M
2x 1/2 drawer S
4x 1/2 drawer M

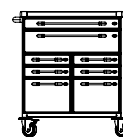

ZV2114N*
1x drawer S a M
4x 1/2 drawer S
2x 1/2 drawer L

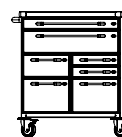

ZV2115N*
1x drawer S a M
2x 1/2 drawer S
1x 1/2 drawer M
2x 1/2 drawer L

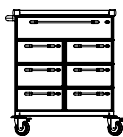

ZV2116N*
1x drawer M
6x 1/2 drawer M

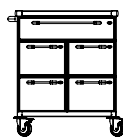

ZV2117N*
1x drawer M
4x 1/2 drawer L

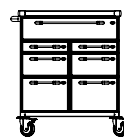

ZV2118N*
1x drawer M
2x 1/2 drawer S
2x 1/2 drawer M
2x 1/2 drawer L

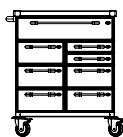

ZV2119N*
1x drawer M
2x 1/2 drawer S
5x 1/2 drawer M

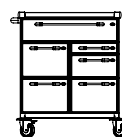

ZV2120N*
1x drawer M
1x 1/2 drawer S
1x 1/2 drawer M
3x 1/2 drawer L

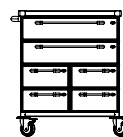

ZV2121N*
2x drawer M
4x 1/2 drawer M

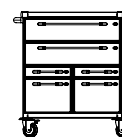

ZV2122N*
2x drawer M
2x 1/2 drawer S
2x 1/2 drawer L

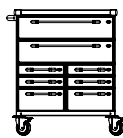

ZV2123N*
2x drawer M
4x 1/2 drawer S
2x 1/2 drawer M

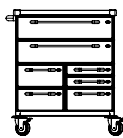

ZV2124N*
2x drawer M
2x 1/2 drawer S
3x 1/2 drawer M

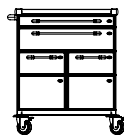

ZV2125N*
1x drawer S a M
2x 1/2 drawer XL

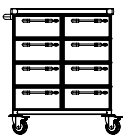

ZV2127N*
8x 1/2 drawer M

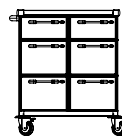

ZV2128N*
2x 1/2 drawer M
4x 1/2 drawer L

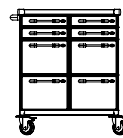

ZV2129N*
4x 1/2 drawer S
4x 1/2 drawer L

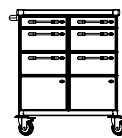

ZV2130N*
2x 1/2 drawer S
2x 1/2 drawer M
2x 1/2 drawer XL

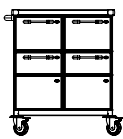

ZV2131N*
2x 1/2 drawer L
2x 1/2 drawer XL

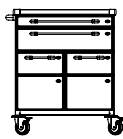

ZV2132N*
1x drawer S a M
2x 1/2 drawer XL
with divider

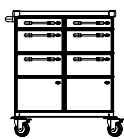

ZV2133N*
2x 1/2 drawer S
2x 1/2 drawer M
2x 1/2 drawer XL
with divider

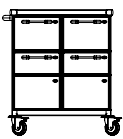

ZV2134N*
2x 1/2 drawer L
2x 1/2 drawer XL
with divider

Don't you know how to select? We will be happy to advise you! Toll free: +420 800 100 798

MULTIFUNCTIONAL CARTS - WITHOUT MODULE SYSTEM

METAL LINE ECO - COMBI

width 75 cm x depth 55 cm

HIGH VERSION

(height 102 cm)

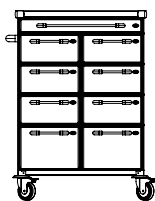
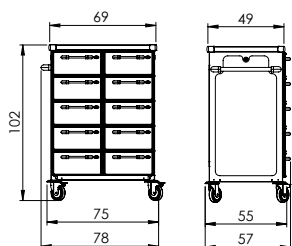

ZV2150N*

1x drawer S
6x 1/2 drawer M
2x 1/2 drawer L

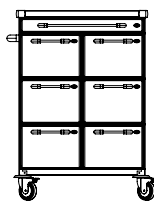

ZV2151N*

1x drawer S
6x 1/2 drawer L

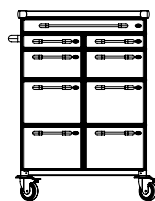

ZV2152N*

1x drawer S
2x 1/2 drawer S
2x 1/2 drawer M
4x 1/2 drawer L

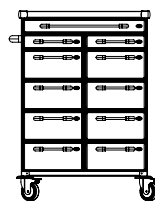

ZV2153N*

1x drawer S
2x 1/2 drawer S
8x 1/2 drawer M

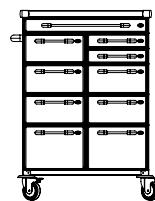

ZV2154N*

1x drawer S
2x 1/2 drawer S
5x 1/2 drawer M
2x 1/2 drawer L

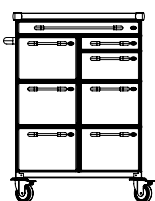

ZV2155N*

1x drawer S
1x 1/2 drawer S
1x 1/2 drawer M
5x 1/2 drawer L

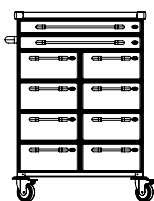

ZV2156N*

2x drawer S
8x 1/2 drawer M

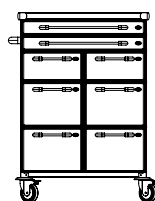

ZV2157N*

2x drawer S
2x 1/2 drawer M
4x 1/2 drawer L

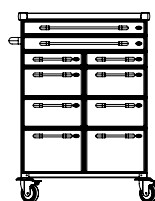

ZV2158N*

2x drawer S
2x 1/2 drawer S
4x 1/2 drawer M
2x 1/2 drawer L

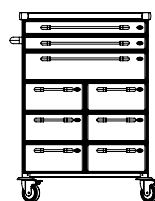

ZV2159N*

2x drawer S
1x drawer M
6x 1/2 drawer M

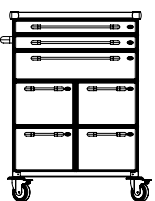

ZV2160N*

2x drawer S
1x drawer M
4x 1/2 drawer L

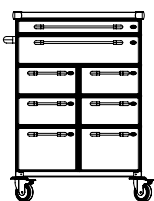

ZV2161N*

1x drawer S a M
4x 1/2 drawer M
2x 1/2 drawer L

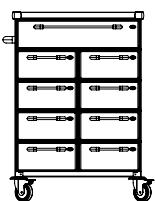

ZV2162N*

1x drawer M
8x 1/2 drawer M

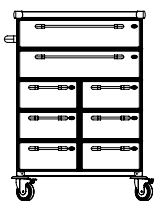

ZV2163N*

2x drawer M
6x 1/2 drawer M

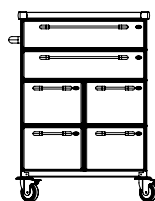

ZV2164N*

2x drawer M
4x 1/2 drawer L

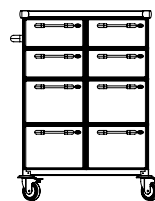

ZV2165N*

4x 1/2 drawer M
4x 1/2 drawer L

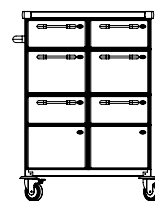

ZV2166N*

2x 1/2 drawer M
2x 1/2 drawer L
2x 1/2 drawer XL

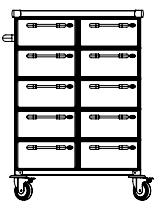

ZV2167N*

10x 1/2 drawer M

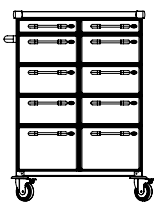

ZV2168N*

2x 1/2 drawer S
6x 1/2 drawer M
2x 1/2 drawer L

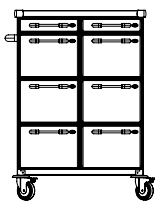

ZV2169N*

2x 1/2 drawer S
6x 1/2 drawer L

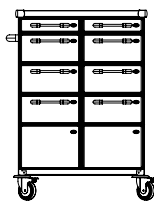

ZV2170N*

2x 1/2 drawer S
4 1/2 drawer M
2x 1/2 drawer XL

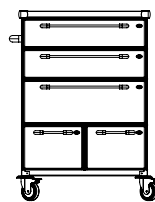

ZV2171N*

2x drawer M
1x drawer L
2x 1/2 drawer L

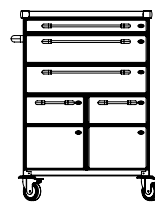

ZV2172N*

1x drawer S
2x drawer M
2x 1/2 drawer XL

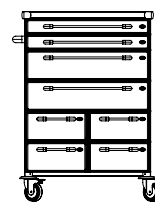

ZV2173N*

2x drawer S a M
4x 1/2 drawer M

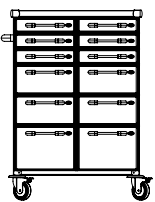

ZV2174N*

6x 1/2 drawer S
4x 1/2 drawer M
2x 1/2 drawer L

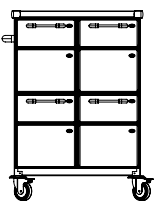

ZV2176N*

4x 1/2 drawer XL

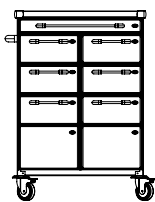

ZV2177N*

1x drawer S
4x 1/2 drawer M
2x 1/2 drawer XL

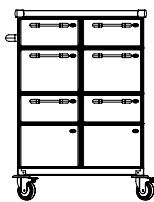

ZV2178N*

2x 1/2 drawer M
2x 1/2 drawer L
2x 1/2 drawer XL
with divider

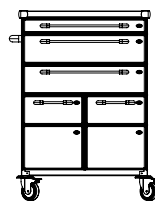

ZV2179N*

1x drawer S
2x drawer M
2x 1/2 drawer XL
with divider

METAL LINE ECO

Don't you know how to select? We will be happy to advise you! Toll free: +420 800 100 798

MULTIFUNCTIONAL CARTS - WITHOUT MODULE SYSTEM

METAL LINE ECO - MAXI



Choose the variant of your cart according to the height of individual drawers:



Steel drawer S size:

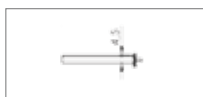

Steel drawer M size:

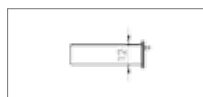

Steel drawer L size:

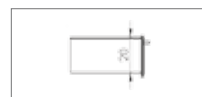

Steel drawer XL size:

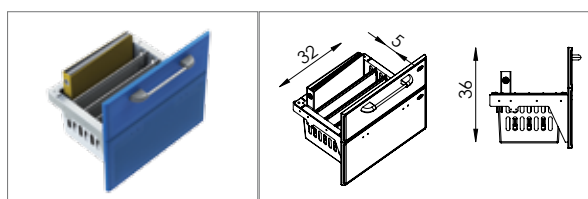

3/4 drawer with divider equipped with a plastic MS basket divided by removable partitions.

Don't you know how to select? We will be happy to advise you! Toll free: +420 800 100 798

MULTIFUNCTIONAL CARTS - WITHOUT MODULE SYSTEM

METAL LINE ECO - MAXI

width 102 cm x depth 50 cm

LOW VERSION
(height 86 cm)

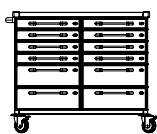
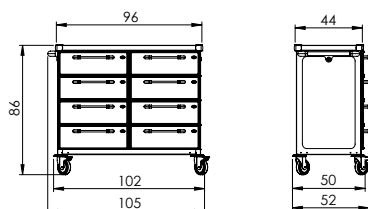

ZV4101N*

8x 3/4 drawer S
4x 3/4 drawer M

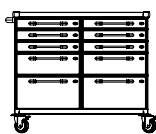

ZV4102N*

6x 3/4 drawer S
2x 3/4 drawer M
2x 3/4 drawer L

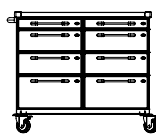

ZV4103N*

2x 3/4 drawer S
4x 3/4 drawer M
2x 3/4 drawer L

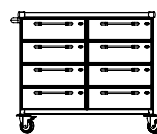

ZV4104N*

8x 3/4 drawer M

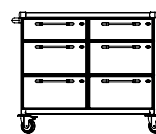

ZV4105N*

2x 3/4 drawer M
4x 3/4 drawer L

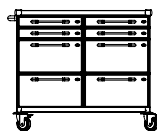

ZV4106N*

4x 3/4 drawer S
4x 3/4 drawer L

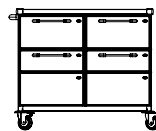

ZV4108N*

2x 3/4 drawer L
2x 3/4 drawer XL

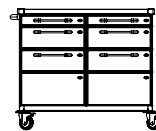

ZV4109N*

2x 3/4 drawer S
2x 3/4 drawer M
2x 3/4 drawer XL

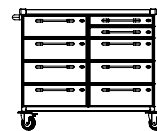

ZV4111N*

2x 3/4 drawer S
7x 3/4 drawer M

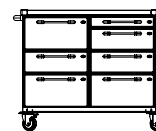

ZV4112N*

1x 3/4 drawer S
3x 3/4 drawer M
3x 3/4 drawer L

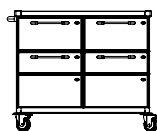

ZV4113N*

2x 3/4 drawer L
2x 3/4 zrusvka XL
s pořadačem

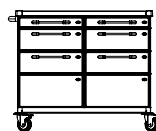

ZV4114N*

2x 3/4 drawer S
2x 3/4 drawer M
2x 3/4 drawer XL
with divider

HIGH VERSION
(height 102 cm)

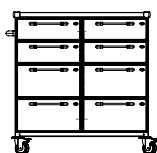
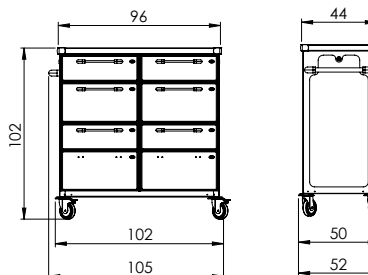

ZV4151N*

4x 3/4 drawer M
4x 3/4 drawer L

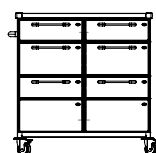

ZV4152N*

2x 3/4 drawer M
2x 3/4 drawer L
2x 3/4 drawer XL

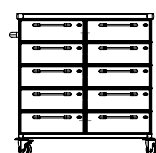

ZV4153N*

10x 3/4 drawer M

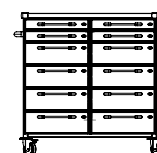

ZV4154N*

4x 3/4 drawer S
8x 3/4 drawer M

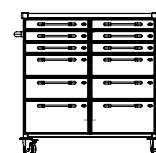

ZV4155N*

6x 3/4 drawer S
4x 3/4 drawer M
2x 3/4 drawer L

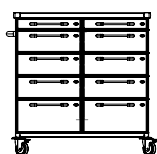

ZV4156N*

2x 3/4 drawer S
6x 3/4 drawer M
2x 3/4 drawer L

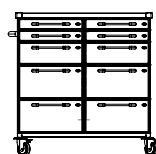

ZV4157N*

4x 3/4 drawer S
2x 3/4 drawer M
4x 3/4 drawer L

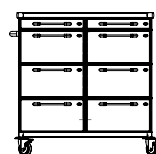

ZV4158N*

2x 3/4 drawer S
6x 3/4 drawer L

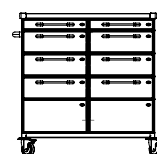

ZV4159N*

2x 3/4 drawer S
4x 3/4 drawer M
2x 3/4 drawer XL

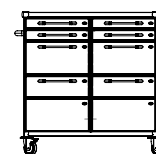

ZV4160N*

4x 3/4 drawer S
2x 3/4 drawer L
2x 3/4 drawer XL

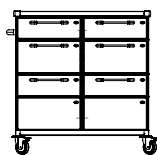

ZV4161N*

2x 3/4 drawer M
2x 3/4 drawer L
2x 3/4 drawer XL
with divider

METAL LINE ECO

Don't you know how to select? We will be happy to advise you! Toll free: +420 800 100 798

MULTIFUNCTIONAL CARTS - WITHOUT MODULE SYSTEM

METAL LINE ECO - MAXI OPEN



HIGH VERSION ONLY (height 102 cm)

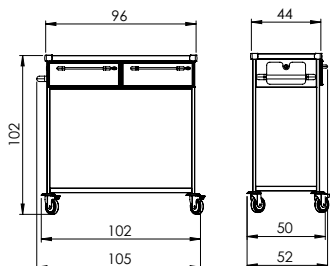

ZV4401N* 2x 3/4 drawer M	ZV4402N* 2x 3/4 drawer L	ZV4403N* 4x 3/4 drawer M	ZV4404N* 2x 3/4 drawer M 2x 3/4 drawer L	ZV4405N* 6x 3/4 drawer M
ZV4406N* 2x 3/4 drawer S 2x 3/4 drawer M 2x 3/4 drawer L	ZV4407N* 2x 3/4 drawer S 3x 3/4 drawer M	ZV4408N* 2x 3/4 drawer S 1x 3/4 drawer M	ZV4409N* 1x 3/4 drawer S 1x 3/4 drawer M 1x 3/4 drawer L	ZV4410N* 4x 3/4 drawer S

Choose the variant of your cart according to the height of individual drawers:

Steel drawer S size:



Steel drawer M size:

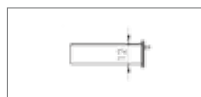

Steel drawer L size:

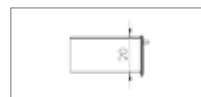

Don't you know how to select? We will be happy to advise you! Toll free: +420 800 100 798

MULTIFUNCTIONAL CARTS - WITHOUT MODULE SYSTEM

METAL LINE ECO - MAXI OPEN PLUS

Desktop made standardly of stainless steel AISI304 with shallow depth and four curved plastic elements (ABS) in desktop corners. Load of desktop: max. 20 kg.

Drawers equipped with removable plastic MS basket.

Plastic basket can be divided using partitions - for variations of division see p. 89.

Drawers central locking.

Steel handle with powder coating grey RAL7042.

Drawer handles, including the push one, inserted to plastic clips.

Cart construction made of steel with powder coating grey RAL7042.

Drawer covered by compact face made of cured plastic (ABS) with rounded corners and edges.

For options of supply of complements, see p. 82-85. With these complements you may assemble multi-purpose carts, see p. 80.

Bottom shelf made of steel with powder coating grey RAL7042.

Four round plastic bumpers.

For options of colour design of drawer frontss see p. 86.

3/4 drawer size. For dimensions see p. 86.

Drawers equipped with full telescopic ball sliding buffer and damper.

4x quality galvanized caster Ø 10 cm, 2x brake.

Total load capacity of cart max. 150 kg.

HIGH VERSION ONLY (height 102 cm)

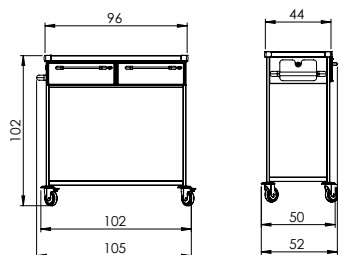

ZV4501N* 2x 3/4 drawer M	ZV4502N* 2x 3/4 drawer L	ZV4503N* 4x 3/4 drawer M	ZV4504N* 2x 3/4 drawer M 2x 3/4 drawer L	ZV4505N* 6x 3/4 drawer M
ZV4506N* 2x 3/4 drawer S 2x 3/4 drawer M 2x 3/4 drawer L	ZV4507N* 2x 3/4 drawer S 3x 3/4 drawer M	ZV4508N* 2x 3/4 drawer S 1x 3/4 drawer M	ZV4509N* 1x 3/4 drawer S 1x 3/4 drawer M 1x 3/4 drawer L	ZV4510N* 4x 3/4 drawer S

Internal division of MS baskets, see p. 89.

Choose the variant of your cart according to the height of individual drawers:

MS drawer velikost S:

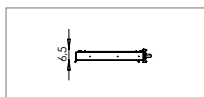

MS drawer velikost M:

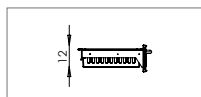

MS drawer velikost L:

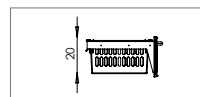

Don't you know how to select? We will be happy to advise you! Toll free: +420 800 100 798

MULTIFUNCTIONAL CARTS - WITHOUT MODULE SYSTEM

METAL LINE ECO - MINI

For options of supply of complements, see p. 82-85.

With these complements you may assemble multipurpose carts, see p. 80.

Desktop made standardly of stainless steel AISI304

with shallow depth and four curved plastic elements (ABS) in desktop corners.

Load of desktop: max. 20 kg.

Steel handle with powder coating RAL7042, colour grey.

Drawer handles, including the push one, inserted to plastic clips.

Cart construction made of steel with powder coating grey RAL7042.

Drawers central locking.

Drawer covered by compact face made of cured plastic (ABS) with rounded corners and edges.

3/4 drawer size.

For dimensions see p. 86.

Drawers equipped with full telescopic ball sliding buffer and damper.

For options of colour design of drawer fronts see p. 86.

Steel drawers with powder coating RAL7042, colour grey.



Four round plastic bumpers.

4x quality galvanized caster Ø 10 cm, 2x brake.

Total load capacity of cart max. 150 kg.



METAL LINE ECO

Choose the variant of your cart according to the height of individual drawers:

Steel drawer S size:

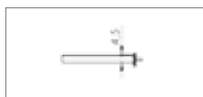

Steel drawer M size:

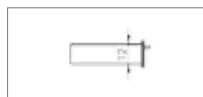

Steel drawer L size:

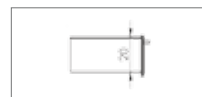

Steel drawer XL size:

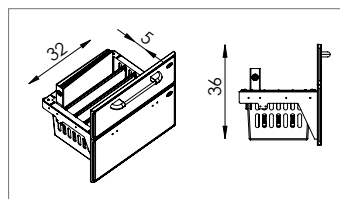

3/4 drawer with divider equipped with a plastic MS basket divided by removable partitions.

Don't you know how to select? We will be happy to advise you! Toll free: +420 800 100 798

MULTIFUNCTIONAL CARTS - WITHOUT MODULE SYSTEM

METAL LINE ECO - MINI

width 55 cm x depth 50 cm

LOW VERSION
(height 86 cm)

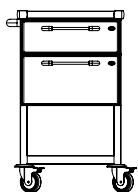
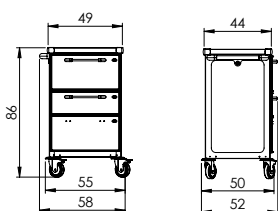

ZV3100N*

1x 3/4 drawer M
1x 3/4 drawer L

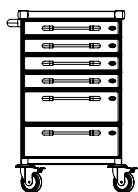

ZV3101N*

4x 3/4 drawer S
2x 3/4 drawer M

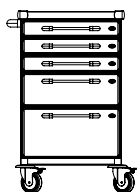

ZV3102N*

3x 3/4 drawer S
1x 3/4 drawer M
1x 3/4 drawer L

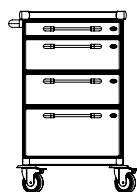

ZV3103N*

1x 3/4 drawer S
2x 3/4 drawer M
1x 3/4 drawer L

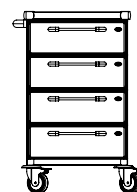

ZV3104N*

4x 3/4 drawer M

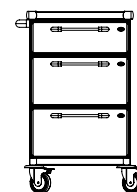

ZV3105N*

1x 3/4 drawer M
2x 3/4 drawer L

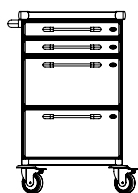

ZV3106N*

2x 3/4 drawer S
2x 3/4 drawer L

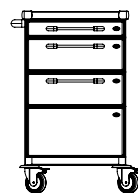

ZV3107N*

1x 3/4 drawer S
1x 3/4 drawer M
1x 3/4 drawer XL

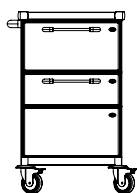

ZV3108N*

1x 3/4 drawer L
1x 3/4 drawer XL

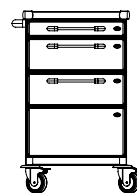

ZV3109N*

1x 3/4 drawer S
1x 3/4 drawer M
1x 3/4 drawer XL
with divider

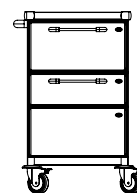

ZV3110N*

1x 3/4 drawer L
1x 3/4 drawer XL
with divider

HIGH VERSION
(height 102 cm)

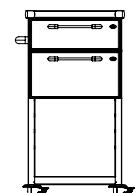
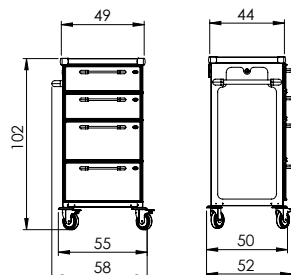

ZV3150N*

1x 3/4 drawer M
1x 3/4 drawer L

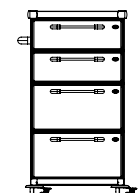

ZV3151N*

2x 3/4 drawer M
2x 3/4 drawer L

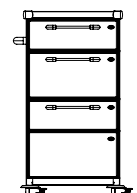

ZV3152N*

1x 3/4 drawer M
1x 3/4 drawer L
1x 3/4 drawer XL

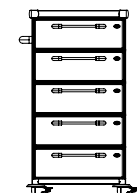

ZV3153N*

5x 3/4 drawer M

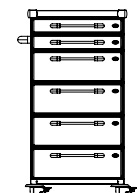

ZV3154N*

2x 3/4 drawer S
4x 3/4 drawer M

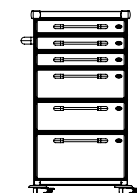

ZV3155N*

3x 3/4 drawer S
2x 3/4 drawer M
1x 3/4 drawer L

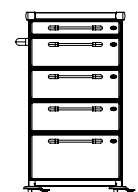

ZV3156N*

1x 3/4 drawer S
3x 3/4 drawer M
1x 3/4 drawer L

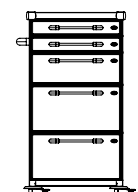

ZV3157N*

2x 3/4 drawer S
1x 3/4 drawer M
2x 3/4 drawer L

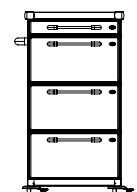

ZV3158N*

1x 3/4 drawer S
3x 3/4 drawer L

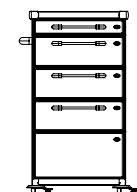

ZV3159N*

1x 3/4 drawer S
2x 3/4 drawer M
1x 3/4 drawer XL

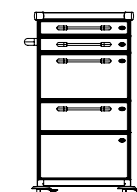

ZV3160N*

2x 3/4 drawer S
1x 3/4 drawer L
1x 3/4 drawer XL

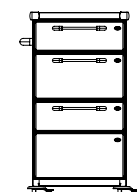

ZV3163N*

1x 3/4 drawer M
1x 3/4 drawer L
1x 3/4 drawer XL
with divider

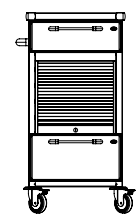

ZV3170N*

1x 3/4 drawer M
1x 3/4 drawer L
2x shelf
1x ABS roller shutter

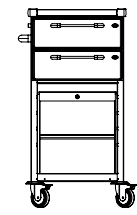

ZV3171N*

2x 3/4 drawer M
2x fixed shelf
1x ABS roller shutter

METAL LINE ECO

Don't you know how to select? We will be happy to advise you! Toll free: +420 800 100 798

MULTIFUNCTIONAL CARTS - WITHOUT MODULE SYSTEM

METAL LINE ECO - PICCOLO



LOW VERSION ONLY (height 86 cm)

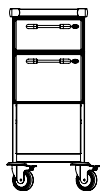
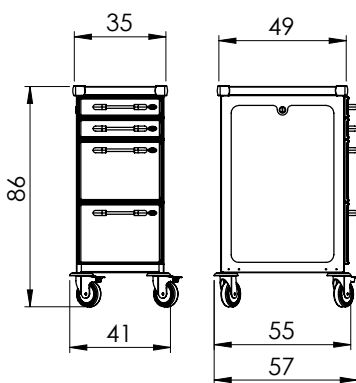

ZV5100N*

1x 1/2 drawer M
1x 1/2 drawer L
1x fixed shelf (bottom)



ZV5102N*

3x 1/2 drawer S
1x 1/2 drawer M
1x 1/2 drawer L

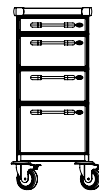

ZV5103N*

1x 1/2 drawer S
2x 1/2 drawer M
1x 1/2 drawer L

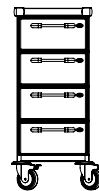

ZV5104N*

4x 1/2 drawer M

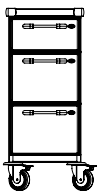

ZV5105N*

1x 1/2 drawer M
2x 1/2 drawer L

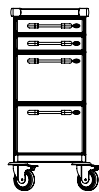

ZV5106N*

2x 1/2 drawer S
2x 1/2 drawer L

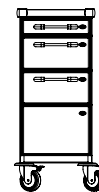

ZV5107N*

1x 1/2 drawer S
1x 1/2 drawer M
1x 1/2 drawer XL

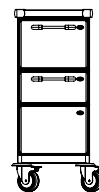

ZV5108N*

1x 1/2 drawer L
1x 1/2 drawer XL

Choose the variant of your cart according to the height of individual drawers:

Steel drawer S size:



Steel drawer M size:

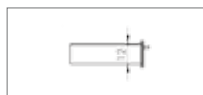

Steel drawer L size:

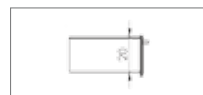

Steel drawer XL size:



Don't you know how to select? We will be happy to advise you! Toll free: +420 800 100 798

MULTIFUNCTIONAL CARTS - WITHOUT MODULE SYSTEM

MEDICINAL CARTS

LOW VERSION



HIGH VERSION



BANDAGE CARTS

LOW VERSION



HIGH VERSION



Don't you know how to select? We will be happy to advise you! Toll free: +420 800 100 798

MULTIFUNCTIONAL CARTS - WITHOUT MODULE SYSTEM

DOCTOR VISIT CARTS LOW VERSION



HIGH VERSION



BANDAGE CARTS

LOW VERSION

HIGH VERSION

MEDICINAL CARTS

LOW VERSION

HIGH VERSION



TYPE CARTS WITH COMPLEMENTS

MAXI OPEN PLUS LINE

MINI LINE

HIGH VERSION ONLY

LOW VERSION

HIGH VERSION



Don't you know how to select? We will be happy to advise you! Toll free: +420 800 100 798



DESKTOPS

We offer an outline of complements on the following pages that can be used for most carts.

At the final part, we offer selection of colours that you can choose for your carts or combine them in different ways.

FOR LINES METAL LINE ECO STANDARD, OPEN, COMBI METAL LINE BASIC, PROFI STANDARD, COMBI

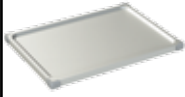
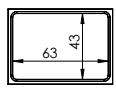

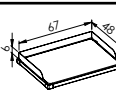
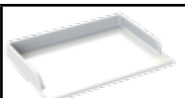
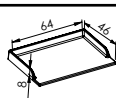
		Desktop made of stainless steel AISI304 with frame 1,2 cm and 4 protective plastic corners - set. LOAD CAPACITY: max. 20 kg.
		Desktop made of stainless steel AISI304 with sides and 4 protective plastic corners - set. LOAD CAPACITY: max. 20 kg.
		Desktop made of stainless steel AISI304 with sides and 4 protective plastic corners - set. LOAD CAPACITY: max. 20 kg.

FOR LINES METAL LINE ECO - MAXI, MAXI OPEN, MAXI OPEN PLUS METAL LINE BASIC, PROFI - MAXI

		Desktop made of stainless steel AISI304 with shallow depth and 4 protective plastic corners - set. LOAD CAPACITY: max. 20 kg.			Desktop made of stainless steel AISI304 with sides and 4 protective plastic corners - set. LOAD CAPACITY: max. 20 kg.
-------------------------------------------------------------------------------------	-------------------------------------------------------------------------------------	----------------------------------------------------------------------------------------------------------------------------------	-------------------------------------------------------------------------------------	--------------------------------------------------------------------------------------	--------------------------------------------------------------------------------------------------------------------------

FOR LINES METAL LINE ECO, BASIC, PROFI - MINI

		Desktop made of stainless steel AISI304 with shallow depth and 4 protective plastic corners - set. LOAD CAPACITY: max. 20 kg.			Desktop made of stainless steel AISI304 with sides and 4 protective plastic corners - set. LOAD CAPACITY: max. 20 kg.
-------------------------------------------------------------------------------------	-------------------------------------------------------------------------------------	----------------------------------------------------------------------------------------------------------------------------------	-------------------------------------------------------------------------------------	--------------------------------------------------------------------------------------	--------------------------------------------------------------------------------------------------------------------------



FOR LINES METAL LINE ECO, BASIC, PROFI - PICCOLO

		Desktop made of stainless steel AISI304 with shallow depth and 4 protective plastic corners - set. LOAD CAPACITY: max. 20 kg.			Desktop made of stainless steel AISI304 with sides and 4 protective plastic corners - set. LOAD CAPACITY: max. 20 kg.
-------------------------------------------------------------------------------------	-------------------------------------------------------------------------------------	----------------------------------------------------------------------------------------------------------------------------------	-------------------------------------------------------------------------------------	--------------------------------------------------------------------------------------	--------------------------------------------------------------------------------------------------------------------------

Don't you know how to select? We will be happy to advise you! Toll free: +420 800 100 798

MULTIFUNCTIONAL CARTS - ACCESSORIES

COMPLEMENTS AND ACCESSORIES

  **5x plastic tilting box**
with arremstment for small healthcare material - set.

CART LINES cat. No.	OPEN	ECO 5775ECO*	BASIC	PROFI
STANDARD	X	✓	X	X
OPEN	X	X	X	X
COMBI	X	✓	X	X
MAXI	X	✓	X	X
MAXI OPEN	X	X	X	X
MAXI OPEN PLUS	X	X	X	X
MINI	X	X	X	X

  **4x plastic tilting box**
with arremstment for small healthcare material - set.

CART LINES cat. No.	OPEN	ECO 5776ECO*	BASIC	PROFI
STANDARD	X	✓	X	X
OPEN	X	X	X	X
COMBI	X	✓	X	X
MAXI	X	✓	X	X
MAXI OPEN	X	X	X	X
MAXI OPEN PLUS	X	X	X	X
MINI	X	X	X	X

  **9x plastic tilting box**
with arremstment for small healthcare material - set.



CART LINES cat. No.	OPEN	ECO 5770ECO*	BASIC 5770*	PROFI 5770*
STANDARD	X	✓	✓	✓
OPEN	X	X	X	X
COMBI	X	✓	✓	✓
MAXI	X	✓	✓	✓
MAXI OPEN	X	X	X	X
MAXI OPEN PLUS	X	X	X	X
MINI	X	X	X	X

  **10x plastic tilting box**
with arremstment for small healthcare material - set.



CART LINES cat. No.	OPEN	ECO 5771ECO*	BASIC 5771*	PROFI 5771*
STANDARD	X	✓	✓	✓
OPEN	X	X	X	X
COMBI	X	✓	✓	✓
MAXI	X	✓	✓	✓
MAXI OPEN	X	X	X	X
MAXI OPEN PLUS	X	X	X	X
MINI	X	X	X	X

  **14x plastic tilting box**
with arremstment for small healthcare material - set.



CART LINES cat. No.	OPEN	ECO	BASIC 5771*	PROFI 5771*
STANDARD	X	X	✓	✓
OPEN	X	X	X	X
COMBI	X	X	✓	✓
MAXI	X	X	✓	✓
MAXI OPEN	X	X	X	X
MAXI OPEN PLUS	X	X	X	X
MINI	X	X	X	X

  **Small cabinet made of stainless steel AISI304**
with lockable and dust-tight door for small healthcare material - set.

CART LINES cat. No.	OPEN	ECO 5773ECO*	BASIC 5773*	PROFI 5773*
STANDARD	X	✓	✓	✓
OPEN	X	X	X	X
COMBI	X	✓	✓	✓
MAXI	X	✓	✓	✓
MAXI OPEN	X	X	X	X
MAXI OPEN PLUS	X	X	X	X
MINI	X	X	X	X

  **Rotating infusion holder made of ss AISI304**
with elevation arremstment, fixed to tilting boxes - set.
Range of the height of holder from floor approx. 100 - 195 cm.

CART LINES cat. No.	OPEN	ECO	BASIC 5760*	PROFI 5760*
STANDARD	X	X	✓	✓
OPEN	X	X	X	X
COMBI	X	X	✓	✓
MAXI	X	X	✓	✓
MAXI OPEN	X	X	X	X
MAXI OPEN PLUS	X	X	X	X
MINI	X	X	X	X

  **Rotating infusion holder made of ss AISI304**
with elevation arremstment, fixed to the cart - set.
Range of the height of holder from floor approx. 160-195 cm.

CART LINES cat. No.	OPEN	ECO	BASIC 5761*	PROFI 5761*
STANDARD	X	X	✓	✓
OPEN	X	X	X	X
COMBI	X	X	✓	✓
MAXI	X	X	✓	✓
MAXI OPEN	X	X	X	X
MAXI OPEN PLUS	X	X	X	X
MINI	X	X	✓	✓

  **Stainless steel AISI304 depository shelf**
for small healthcare material, removable - set.

CART LINES cat. No.	OPEN	ECO 5782ECO*	BASIC 5782*	PROFI 5782*
STANDARD	X	✓	✓	✓
OPEN	X	X	X	X
COMBI	X	✓	✓	✓
MAXI	X	✓	✓	✓
MAXI OPEN	X	X	X	X
MAXI OPEN PLUS	X	X	X	X
MINI	X	X	X	X



  **Stainless steel AISI304 depository shelf**
for small healthcare material, removable - set.

CART LINES cat. No.	OPEN	ECO 5882ECO*	BASIC 5882*	PROFI 5882*
STANDARD	X	X	X	X
OPEN	X	X	X	X
COMBI	X	X	X	X
MAXI	X	X	X	X
MAXI OPEN	X	X	X	X
MAXI OPEN PLUS	X	X	X	X
MINI	X	X	✓	✓

Don't you know how to select? We will be happy to advise you! Toll free: +420 800 100 798



MULTIFUNCTIONAL CARTS - ACCESSORIES

COMPLEMENTS AND ACCESSORIES



Double shelf made of stainless steel AISI304
for small healthcare material, removable - set. Load at single shelf: 3 kg.

CART LINES	OPEN	ECO	BASIC	PROFI
cat. No.		5892ECO*	5892*	5892*
STANDARD	X	X	X	X
OPEN	X	X	X	X
COMBI	X	X	X	X
MAXI	X	✓	✓	✓
MAXI OPEN	X	X	X	X
MAXI OPEN PLUS	X	X	X	X
MINI	X	X	X	X

Holder for 100 pcs. of gloves made of ss AISI304
height adjustable - set. Load capacity: 2 kg.

CART LINES	OPEN	ECO	BASIC	PROFI
cat. No.		5781ECO*	5781*	5781*
STANDARD	X	✓	✓	✓
OPEN	X	X	X	X
COMBI	X	✓	✓	✓
MAXI	X	✓	✓	✓
MAXI OPEN	X	X	X	X
MAXI OPEN PLUS	X	X	X	X
MINI	X	✓	✓	✓

Holder for 200 pcs. of gloves made of ss AISI304
adjustable height - set. Load capacity: 2 kg.

CART LINES	OPEN	ECO	BASIC	PROFI
cat. No.		5781XLECO*	5781XL*	5781XL*
STANDARD	X	✓	✓	✓
OPEN	X	X	X	X
COMBI	X	✓	✓	✓
MAXI	X	✓	✓	✓
MAXI OPEN	X	X	X	X
MAXI OPEN PLUS	X	X	X	X
MINI	X	✓	✓	✓



Plastic holder for 100 pcs. of gloves
height adjustable - set. Load capacity: 2 kg.

CART LINES	OPEN	ECO	BASIC	PROFI
cat. No.		5781PECO*	5781P*	5781P*
STANDARD	X	✓	✓	✓
OPEN	X	X	X	X
COMBI	X	✓	✓	✓
MAXI	X	✓	✓	✓
MAXI OPEN	X	X	X	X
MAXI OPEN PLUS	X	X	X	X
MINI	X	✓	✓	✓



Vial opener made of stainless steel AISI304
with dispose container, removable - set.

CART LINES	OPEN	ECO	BASIC	PROFI
cat. No.		5763*	5763*	5763*
STANDARD	X	✓	✓	✓
OPEN	✓	X	X	X
COMBI	X	✓	✓	✓
MAXI	X	✓	✓	✓
MAXI OPEN	✓	X	X	X
MAXI OPEN PLUS	✓	X	X	X
MINI	X	✓	✓	✓





Holder of container for used needles
tape with possibility to change diameter per container - set.

CART LINES	OPEN	ECO	BASIC	PROFI
cat. No.		5757*	5757*	5757*
STANDARD	X	✓	✓	✓
OPEN	X	X	X	X
COMBI	X	✓	✓	✓
MAXI	X	✓	✓	✓
MAXI OPEN	X	X	X	X
MAXI OPEN PLUS	X	X	X	X
MINI	X	X	X	X





Stainless steel AISI304 box for catheters
with transparent front - set.

CART LINES	OPEN	ECO	BASIC	PROFI
cat. No.		5780*	5780*	5780*
STANDARD	X	✓	✓	✓
OPEN	X	X	X	X
COMBI	X	✓	✓	✓
MAXI	X	✓	✓	✓
MAXI OPEN	X	X	X	X
MAXI OPEN PLUS	X	X	X	X
MINI	X	✓	✓	✓



Wire basket made of stainless steel AISI304
removable - set. Load capacity: 3 kg.

CART LINES	OPEN	ECO	BASIC	PROFI
cat. No.		5764OPEN*	5764*	5764*
STANDARD	X	✓	✓	✓
OPEN	✓	X	X	X
COMBI	X	✓	✓	✓
MAXI	X	✓	✓	✓
MAXI OPEN	X	X	X	X
MAXI OPEN PLUS	X	X	X	X
MINI	X	X	X	X

Wire basket made of stainless steel AISI304
removable - set. Load capacity: 3 kg.

CART LINES	OPEN	ECO	BASIC	PROFI
cat. No.		5864OPEN*	5864*	5864*
STANDARD	X	X	X	X
OPEN	X	X	X	X
COMBI	X	X	X	X
MAXI	X	✓	✓	✓
MAXI OPEN	✓	X	X	X
MAXI OPEN PLUS	✓	X	X	X
MINI	X	✓	✓	✓

Wire basket made of stainless steel AISI304
removable - set. Load capacity: 3 kg.

CART LINES	OPEN	ECO	BASIC	PROFI
cat. No.		5765OPEN*	5765*	5765*
STANDARD	X	✓	✓	✓
OPEN	✓	X	X	X
COMBI	X	✓	✓	✓
MAXI	X	X	X	X
MAXI OPEN	X	X	X	X
MAXI OPEN PLUS	X	X	X	X
MINI	X	X	X	X

Don't you know how to select? We will be happy to advise you! Toll free: +420 800 100 798

MULTIFUNCTIONAL CARTS - ACCESSORIES

COMPLEMENTS AND ACCESSORIES



Folding desk made of stainless steel AISI304
with safety belts - set.
Load capacity: 10 kg.

CART LINES	OPEN	ECO	BASIC	PROFI
cat. No.		5759*	5759*	5759*
STANDARD	X	✓	✓	✓
OPEN	X	X	X	X
COMBI	X	✓	✓	✓
MAXI	X	✓	✓	✓
MAXI OPEN	X	X	X	X
MAXI OPEN PLUS	X	X	X	X
MINI	X	X	X	X



Plastic waste bin
removable - set.
Volume: 8l.

CART LINES	OPEN	ECO	BASIC	PROFI
cat. No.	5754AOPEN*	5754A*	5754A*	5754A*
STANDARD	X	✓	✓	✓
OPEN	✓	X	X	X
COMBI	X	✓	✓	✓
MAXI	X	✓	✓	✓
MAXI OPEN	✓	X	X	X
MAXI OPEN PLUS	✓	X	X	X
MINI	X	✓	✓	✓





Rotate table made of stainless steel AISI304
with safety belts - set.
Load capacity: 10 kg.

CART LINES	OPEN	ECO	BASIC	PROFI
cat. No.		5756*	5756*	5756*
STANDARD	X	✓	✓	✓
OPEN	X	X	X	X
COMBI	X	✓	✓	✓
MAXI	X	✓	✓	✓
MAXI OPEN	X	X	X	X
MAXI OPEN PLUS	X	X	X	X
MINI	X	X	X	X



Folding table made of stainless steel AISI304
with frame and protective plastic corners - set. Load capacity: 8kg.
It is not possible to combine the desk with another accessory on the same side - low cart version.

CART LINES	OPEN	ECO	BASIC	PROFI
cat. No.	5853ZN*	5853ZN*	5853ZN*	5853ZN*
STANDARD	X	X	X	X
OPEN	X	X	X	X
COMBI	X	X	X	X
MAXI	X	✓	✓	✓
MAXI OPEN	✓	X	X	X
MAXI OPEN PLUS	✓	X	X	X
MINI	X	✓	✓	✓

Electrical socket ledge (4x 230V, turned by 45°)
also for angled plugs with aluminum protective case serving as container for 1.8m cable. Ledge is equipped with lighted safety switch and protective contact - set.

CART LINES	OPEN	ECO	BASIC	PROFI
cat. No.			5787*	5787*
STANDARD	X	X	X	X
OPEN	X	X	X	X
COMBI	X	X	X	X
MAXI	X	X	✓	✓
MAXI OPEN	X	X	✓	✓
MAXI OPEN PLUS	X	X	X	X
MINI	X	X	✓	✓



Stainless steel AISI304 container for inf. waste
removable - set.
Volume: 15l.

CART LINES	OPEN	ECO	BASIC	PROFI
cat. No.	5754OPEN*	5754*	5754*	5754*
STANDARD	X	✓	✓	✓
OPEN	✓	X	X	X
COMBI	X	✓	✓	✓
MAXI	X	✓	✓	✓
MAXI OPEN	✓	X	X	X
MAXI OPEN PLUS	✓	X	X	X
MINI	X	✓	✓	✓



Plastic waste bin with touch less opening
and inner removable insert - set.
Only for a high cart version to be opened by a knee. Mostly is not possible to combine with another accessory on the same side.

CART LINES	OPEN	ECO	BASIC	PROFI
cat. No.			5754B*	5754B*
STANDARD	X	X	✓	✓
OPEN	X	X	X	X
COMBI	X	X	✓	✓
MAXI	X	X	✓	✓
MAXI OPEN	X	X	X	X
MAXI OPEN PLUS	X	X	X	X
MINI	X	X	✓	✓



Folding table made of stainless steel AISI304
with frame and protective plastic corners - set. Load capacity: 10kg.
It is not possible to combine the desk with another accessory on the same side - low cart version.

CART LINES	OPEN	ECO	BASIC	PROFI
cat. No.	5753ZN*	5753ZN*	5753ZN*	5753ZN*
STANDARD	X	✓	✓	✓
OPEN	✓	X	X	X
COMBI	X	✓	✓	✓
MAXI	X	X	X	X
MAXI OPEN	X	X	X	X
MAXI OPEN PLUS	X	X	X	X
MINI	X	X	X	X



Stainless steel AISI304 oxygen bottle (2kg) holder
with safety belts - set.
Average bottle: 5 - 8l.

CART LINES	OPEN	ECO	BASIC	PROFI
cat. No.			5758*	5758*
STANDARD	X	X	✓	✓
OPEN	X	X	X	X
COMBI	X	X	✓	✓
MAXI	X	X	✓	✓
MAXI OPEN	X	X	X	X
MAXI OPEN PLUS	X	X	X	X
MINI	X	X	✓	✓





Resuscitation pad made of highly resist.mat. HPL
COMPACT with auto disinfectant action - set.

CART LINES	OPEN	ECO	BASIC	PROFI
cat. No.			5762*	5762*
STANDARD	X	X	✓	✓
OPEN	X	X	X	X
COMBI	X	X	✓	✓
MAXI	X	X	✓	✓
MAXI OPEN	X	X	X	X
MAXI OPEN PLUS	X	X	X	X
MINI	X	X	X	X

Don't you know how to select? We will be happy to advise you! Toll free: +420 800 100 798

MULTIFUNCTIONAL CARTS - ACCESSORIES

COMPLEMENTS AND ACCESSORIES



Stainless steel AISI304 universal ledge (euroledge)
for accessories - set. Can be placed on the side or the back of cart at horizontal/vertical position per customer's choice. Load capacity: 10kg.

CART LINES cat. No.	OPEN	ECO 5788*	BASIC 5788*	PROFI 5788*
STANDARD	X	✓	✓	✓
OPEN	X	X	X	X
COMBI	X	✓	✓	✓
MAXI	X	✓	✓	✓
MAXI OPEN	X	X	X	X
MAXI OPEN PLUS	X	X	X	X
MINI	X	✓	✓	✓



Stainless steel AISI304 universal ledge (euroledge)
for accessories - set. Can be placed on the side or the back of cart at horizontal/vertical position per customer's choice. Load capacity: 10 kg.

CART LINES cat. No.	OPEN	ECO 5788A*	BASIC 5788A*	PROFI 5788A*
STANDARD	X	✓	✓	✓
OPEN	X	X	X	X
COMBI	X	✓	✓	✓
MAXI	X	✓	✓	✓
MAXI OPEN	X	X	X	X
MAXI OPEN PLUS	X	X	X	X
MINI	X	✓	✓	✓



Stainless steel AISI304 flat pull out desk
- set. Load capacity: 10kg. Addition of this desk will increase the cart height by 4 cm (from the floor).

CART LINES cat. No.	OPEN	ECO	BASIC 5854*	PROFI 5854*
STANDARD	X	X	✓	✓
OPEN	X	X	X	X
COMBI	X	X	✓	✓
MAXI	X	X	X	X
MAXI OPEN	X	X	X	X
MAXI OPEN PLUS	X	X	X	X
MINI	X	X	X	X



Removable divider made of stainless steel AISI304
for 10 medical documentation files - set. Divider is only for the bottom shelf of ECO OPEN line carts.

CART LINES cat. No.	OPEN 5789OPEN*	ECO	BASIC	PROFI
STANDARD	X	X	X	X
OPEN	✓	X	X	X
COMBI	X	X	X	X
MAXI	X	X	X	X
MAXI OPEN	X	X	X	X
MAXI OPEN PLUS	X	X	X	X
MINI	X	X	X	X



Additional box with 2x pull out pocket
made of stainless steel AISI304 for small healthcare material. Dust-tight fronts of pockets (made of ABS plastic). Options of colour design of fronts. Central locking. Can be used for left or right side of cart - set. Load at single pocket: 3 kg. FOR LOW VERSION ONLY!

CART LINES cat. No.	OPEN	ECO	BASIC 5790*	PROFI 5790*
STANDARD	X	X	✓	✓
COMBI	X	X	✓	✓



Additional box with 3x pull out pocket
made of stainless steel AISI304 for small healthcare material. Dust-tight fronts of pockets (made of ABS plastic). Options of colour design of fronts. Central locking. Can be used for left or right side of cart - set. Load at single pocket: 3 kg. FOR HIGH VERSION ONLY!

CART LINES cat. No.	OPEN	ECO	BASIC 5791*	PROFI 5791*
STANDARD	X	X	✓	✓
COMBI	X	X	✓	✓



Stacking pocket made of stainless steel AISI304
for documents - set. Load capacity: 5 kg.

CART LINES cat. No.	OPEN	ECO 5755*	BASIC 5755*	PROFI 5755*
STANDARD	X	✓	✓	✓
OPEN	X	X	X	X
COMBI	X	✓	✓	✓
MAXI	X	✓	✓	✓
MAXI OPEN	X	X	X	X
MAXI OPEN PLUS	X	X	X	X
MINI	X	✓	✓	✓



Plastic divider for steel drawer
ONLY for Metal Line ECO - M size drawers (height 12 cm) and L size drawers (height 20 cm).

00101P

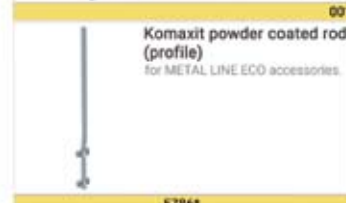

Komaxit powder coated rod (profile)
for METAL LINE ECO accessories.

5786*



Nerezová stojna (D-profil)
for METAL LINE BASIC and PROFI accessories.

5785*

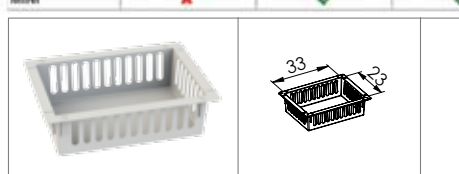

plastic basket - MINI
33 x 23 cm
height 5 cm: 11416
height 10 cm: 11417
height 20 cm: 11418
load capacity: 10 kg



plastic basket - STANDARD
52 x 32 cm
height 5 cm: 11419
height 10 cm: 11420
height 20 cm: 11421
load capacity: 20 kg

Cart lines marked by **X** can be equipped with selected accessories upon your interest.

Don't you know how to select? We will be happy to advise you! Toll free: +420 800 100 798

MULTIFUNCTIONAL CARTS - DRAWERS

STANDARD steel drawer

S size, height 4,5 cm



M size, height 12 cm

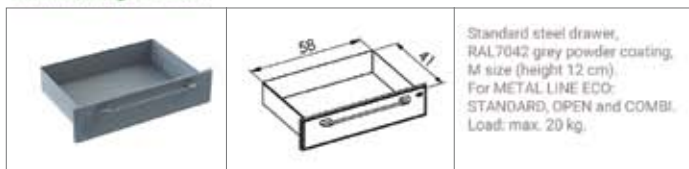

L size, height 20 cm

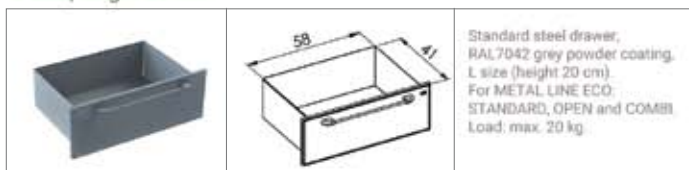

XL size, height 36 cm



DRAWER PLASTIC FRONTS COLOUR SAMPLES:



1/2 steel drawer

S size, height 4,5 cm



M size, height 12 cm

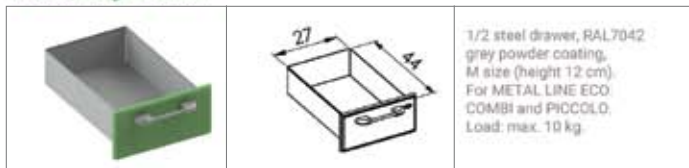

L size, height 20 cm



XL size, height 36 cm



3/4 steel drawer

S size, height 4,5 cm



M size, height 12 cm

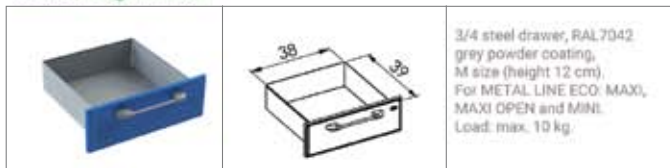

L size, height 20 cm



XL size, height 36 cm



Don't you know how to select? We will be happy to advise you! Toll free: +420 800 100 798

MULTIFUNCTIONAL CARTS - DRAWERS

STANDARD drawer with removable MS BASKET (ISO-size)

S size, height 6,5 cm - MS basket cat. No. 11419

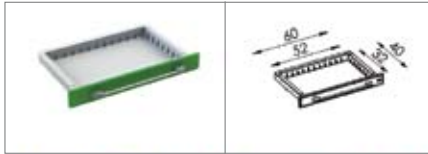

STANDARD drawer equipped with plastic MS basket divided by removable dividers.
S size (height 6,5 cm).
For METAL LINE BASIC, PROFI: STANDARD and COMBI.
Load: max. 20 kg.

M size, height 12 cm - MS basket cat. No. 11420

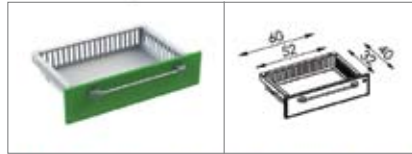

STANDARD drawer equipped with plastic MS basket divided by removable dividers.
M size (height 12 cm).
For METAL LINE BASIC, PROFI: STANDARD and COMBI.
Load: max. 20 kg.

L size, height 20 cm - MS basket cat. No. 11421



STANDARD drawer equipped with plastic MS basket divided by removable dividers.
L size (height 20 cm).
For METAL LINE BASIC, PROFI: STANDARD and COMBI.
Load: max. 20 kg.

XL size, height 36 cm - MS basket cat. No. 11421



STANDARD drawer equipped with plastic MS basket divided by removable dividers.
XL size (height 36 cm).
For METAL LINE BASIC, PROFI: STANDARD and COMBI.
Load: max. 20 kg.

1/2 drawer with removable MS BASKET (ISO-size)

S size, height 6,5 cm - MS basket cat. No. 11416



1/2 drawer equipped with plastic MS basket divided by removable dividers.
S size (height 6,5 cm).
For METAL LINE BASIC, PROFI: COMBI and PICCOLO.
Load: max. 10 kg.

M size, height 12 cm - MS basket cat. No. 11417

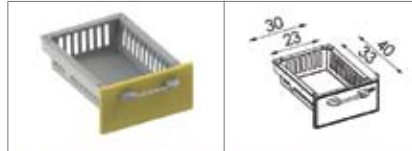

1/2 drawer equipped with plastic MS basket divided by removable dividers.
M size (height 12 cm).
For METAL LINE BASIC, PROFI: COMBI and PICCOLO.
Load: max. 10 kg.

L size, height 20 cm - MS basket cat. No. 11418



1/2 drawer equipped with plastic MS basket divided by removable dividers.
L size (height 20 cm).
For METAL LINE BASIC, PROFI: COMBI and PICCOLO.
Load: max. 10 kg.

XL size, height 36 cm - MS basket cat. No. 11418



1/2 drawer equipped with plastic MS basket divided by removable dividers.
XL size (height 36 cm).
For METAL LINE BASIC, PROFI: COMBI and PICCOLO.
Load: max. 10 kg.

3/4 drawer with removable MS BASKET (ISO-size)

S size, height 6,5 cm - MS basket cat. No. 11416



3/4 drawer equipped with plastic MS basket divided by removable dividers.
S size (height 6,5 cm).
For METAL LINE ECO: MAXI OPEN PLUS; BASIC, PROFL, MAXI and MINI.
Load: max. 10 kg.

M size, height 12 cm - MS basket cat. No. 11417



3/4 drawer equipped with plastic MS basket divided by removable dividers.
M size (height 12 cm).
For METAL LINE ECO: MAXI OPEN PLUS; BASIC, PROFL, MAXI and MINI.
Load: max. 10 kg.

L size, height 20 cm - MS basket cat. No. 11418

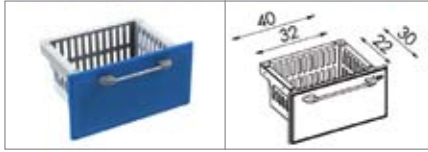

3/4 drawer equipped with plastic MS basket divided by removable dividers.
L size (height 20 cm).
For METAL LINE ECO: MAXI OPEN PLUS; BASIC, PROFL, MAXI and MINI.
Load: max. 10 kg.

XL size, height 36 cm - MS basket cat. No. 11418



3/4 drawer equipped with plastic MS basket divided by removable dividers.
XL size (height 36 cm).
For METAL LINE ECO: MAXI OPEN PLUS; BASIC, PROFL, MAXI and MINI.
Load: max. 10 kg.

DOCUMENTATION drawer

Standard drawer ECO line for 11 medical docum. files

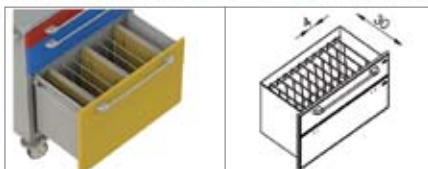

Standard steel drawer with divider for 11 medical documentation files. Dividers can be removed to insert larger files.
XL size (height 36 cm).
For METAL LINE ECO STANDARD documentation.
Load: max. 20 kg.

Standard drawer BASIC and PROFI line for 16 medical docum. files

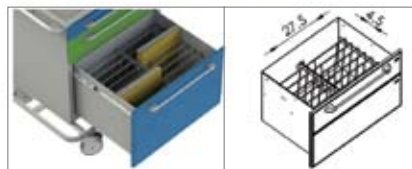

Standard steel drawer with divider for 16 medical documentation files. Dividers can be removed to insert larger files.
XL size (height 36 cm).
For METAL LINE BASIC, PROFI: STANDARD documentation.
Load: max. 40 kg.

1/2 drawer COMBI for documentation - splitted to 4 divisions



1/2 drawer equipped with plastic MS basket. Standard 4x division, width 5 cm, option to be equipped with more dividers - max. 8x division, width 2 cm. XL size (height 36 cm). For METAL LINE ECO, BASIC, PROFI - COMBI.
Load: max. 10 kg.

3/4 drawer MAXI, MINI for documentation - splitted to 4 divisions



3/4 drawer equipped with plastic MS basket. Standard 4x division, width 5 cm, option to be equipped with more dividers - max. 8x division, width 2 cm. XL size (height 36 cm). For METAL LINE ECO, BASIC, PROFI - MAXI, MINI.
Load: max. 10 kg.

Don't you know how to select? We will be happy to advise you! Toll free: +420 800 100 798

MULTIFUNCTIONAL CARTS - ACCESSORIES

OPTIONS OF MS BASKET VARIABLE DIVISIONS

FOR ALL HEIGHTS (5, 10, 20 CM) OF STANDARD MS BASKETS

MS basket dimensions (cm):

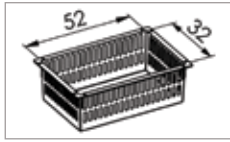

For all MS baskets - STANDARD line
Metal Line BASIC, PROFI - STANDARD, COMBI.

<p>OPTION 1</p>	<p>OPTION 2</p>	<p>OPTION 3</p>	<p>OPTION 4</p>	<p>OPTION 5</p>
<p>OPTION 6</p>	<p>OPTION 7</p>	<p>OPTION 8</p>	<p>OPTION 9</p>	<p>OPTION 10</p>
<p>OPTION 11</p>	<p>OPTION 12</p>	<p>OPTION 13</p>	<p>OPTION 14</p>	<p>OPTION 15</p>
<p>OPTION 16</p>	<p>OPTION 17</p>	<p>OPTION 18</p>	<p>OPTION 19</p>	<p>OPTION 20</p>
<p>OPTION 21</p>	<p>OPTION 22</p>	<p>OPTION 23</p>	<p>OPTION 24</p>	

MULTIFUNCTIONAL CARTS - ACCESSORIES

OPTIONS OF MS BASKET VARIABLE DIVISIONS

FOR 5 AND 10 CM HEIGHTS OF 3/4 AND 1/2 MS BASKETS

MS basket dimensions (cm):

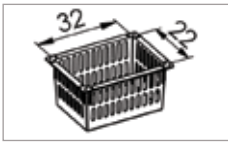

For 3/4 drawers (MS baskets - MINI) size S, M lines
METAL LINE ECO - MAXI OPEN PLUS.

For 3/4 and 1/2 drawers (MS baskets - MINI) size S, M lines
METAL LINE BASIC, PROFI - MINI, MAXI, COMBI, PICCOLO.

<p>OPTION 1</p>	<p>OPTION 2</p>	<p>OPTION 3</p>	<p>OPTION 4</p>	<p>OPTION 5</p>
<p>OPTION 6</p>	<p>OPTION 7</p>	<p>OPTION 8</p>	<p>OPTION 9</p>	<p>OPTION 10</p>
	<p>OPTION 11</p>	<p>OPTION 12</p>	<p>OPTION 13</p>	

FOR 20 CM HEIGHT OF 3/4 AND 1/2 MS BASKETS

<p>OPTION 1</p>	<p>OPTION 2</p>	<p>OPTION 3</p>
-----------------	-----------------	-----------------

For 3/4 drawers (MS baskets - MINI) size L, XL lines METAL LINE ECO - MAXI OPEN PLUS.

For 3/4 and 1/2 drawers (MS baskets - MINI) size L, XL lines METAL LINE BASIC, PROFI - MINI, MAXI, COMBI, PICCOLO.

Don't you know how to select? We will be happy to advise you! Toll free: +420 800 100 798



We also offer carts with MS system, all-stainless steel plates combined with all-stainless steel drawers, instrumentation carts with pneumatic or manual elevation, with desktop turnable by 360°, infection waste carts, etc.

Atypical production according to required dimensions: all-stainless steel racks, cabinets, sinks, desks for carts, etc.

Standard products can be combined with atypical products.



Don't you know how to select? We will be happy to advise you! Toll free: +420 800 100 798

STAINLESS STEEL PLATES - MODULE SYSTEM

STAINLESS STEEL PLATES WITH MODULE SYSTEM

L-LINE

For options of supply of complements, see p. 96.



Drawers central locking.

Drawers equipped with full telescopic ball sliding buffer and damper.

Drawer handles made of stainless steel AISI304. Handles inserted to plastic clips.

For options of colour design of drawer fronts see p. 86.

Dust-tightness of drawers. Drawer fronts equipped with rubber profile along all the circumference.

Self-supporting desktop made of stainless steel AISI304 with frame 12 mm. Desktop load capacity: max. 50 kg.

Drawers equipped with removable plastic MS basket.

Plastic MS basket can be divided using partitions. For variations see p. 88.

Drawer covered by compact face made of cured plastic (ABS) with rounded corners and edges.

Cart construction, including desktops and handles (if it is part of the cart) made of stainless steel AISI304.

4x corner bumper made of resistant (PE) plastic.

4x quality plastic castor Ø 12,5 cm, 2x brake.



Internal division of MS baskets, see p. 88.

Choose the cart variant according to the height of individual drawers:

MS drawer S size:

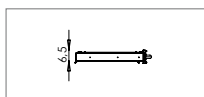

MS drawer M size:

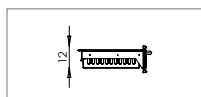

MS drawer L size:

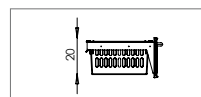

Don't you know how to select? We will be happy to advise you! Toll free: +420 800 100 798

STAINLESS STEEL PLATES - MODULE SYSTEM

STAINLESS STEEL PLATES WITH MODULE SYSTEM

L-LINE - WITH HANDLES

HEIGHT 92 CM

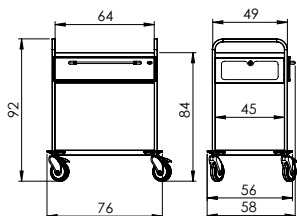

NEREZ2720*
1x drawer M
1x bottom shelf



NEREZ2721*
2x drawer S
1x bottom shelf



NEREZ2722*
1x drawer M
1x pull out basket
1x bottom shelf



NEREZ2723*
2x drawer S
1x pull out basket
1x bottom shelf



NEREZ2724*
2x drawer M
1x bottom shelf



NEREZ2725*
4x drawer S
1x bottom shelf



NEREZ2726*
2x drawer S
1x drawer M
1x bottom shelf



NEREZ2727*
1x drawer S
1x drawer L
1x bottom shelf

HEIGHT 112 CM

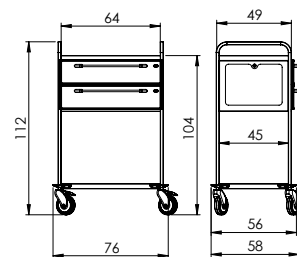

NEREZ2730*
2x drawer M
1x bottom shelf



NEREZ2731*
4x drawer S
1x bottom shelf



NEREZ2732*
2x drawer S
1x drawer M
1x bottom shelf



NEREZ2733*
1x drawer S
1x drawer L
1x bottom shelf



NEREZ2734*
2x drawer M
1x pull out basket
1x bottom shelf



NEREZ2735*
4x drawer S
1x pull out basket
1x bottom shelf



NEREZ2736*
2x drawer S
1x drawer M
1x pull out basket
1x bottom shelf



NEREZ2737*
1x drawer S
1x drawer L
1x pull out basket
1x bottom shelf



NEREZ2738*
2x drawer M
2x bottom shelf



NEREZ2739*
4x drawer S
2x bottom shelf



NEREZ2740*
2x drawer S
1x drawer M
2x bottom shelf



NEREZ2741*
1x drawer S
1x drawer L
2x bottom shelf



NEREZ2742*
2x drawer M
1x pull out basket
2x bottom shelf



NEREZ2743*
4x drawer S
1x pull out basket
2x bottom shelf



NEREZ2744*
2x drawer S
1x drawer M
1x pull out basket
2x bottom shelf



NEREZ2745*
1x drawer S
1x drawer L
1x pull out basket
2x bottom shelf



NEREZ2760*
3x drawer M
1x pull out basket
1x bottom shelf



NEREZ2761*
6x drawer S
1x pull out basket
1x bottom shelf



NEREZ2762*
4x drawer S
1x drawer M
1x bottom shelf



NEREZ2763*
2x drawer S
2x drawer M
1x bottom shelf



NEREZ2764*
1x drawer S
1x drawer M
1x drawer L
1x bottom shelf



NEREZ2765*
3x drawer S
1x drawer L
1x bottom shelf



NEREZ2766*
2x drawer L
1x bottom shelf



NEREZ2767*
3x drawer M
1x pull out basket
1x bottom shelf



NEREZ2768*
6x drawer S
1x pull out basket
1x bottom shelf



NEREZ2769*
4x drawer S
1x drawer M
1x pull out basket
1x bottom shelf



NEREZ2770*
2x drawer S
1x drawer M
1x pull out basket
1x bottom shelf



NEREZ2771*
1x drawer S
1x drawer M
1x drawer L
1x pull out basket



NEREZ2772*
3x drawer S
1x pull out basket
1x bottom shelf



NEREZ2773*
2x drawer L
1x pull out basket
1x bottom shelf

Don't you know how to select? We will be happy to advise you! Toll free: +420 800 100 798

STAINLESS STEEL PLATES - MODULE SYSTEM

STAINLESS STEEL PLATES WITH MODULE SYSTEM

L-LINE - WITHOUT HANDLES

HEIGHT 84 CM

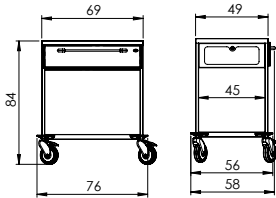

NEREZ2820* 1x drawer M 1x bottom shelf	NEREZ2821* 2x drawer S 1x bottom shelf	NEREZ2822* 1x drawer M 1x pull out basket 1x bottom shelf	NEREZ2823* 2x drawer S 1x pull out basket 1x bottom shelf	NEREZ2824* 2x drawer M 1x bottom shelf	NEREZ2825* 4x drawer S 1x bottom shelf

NEREZ2826* 2x drawer S 1x drawer M 1x bottom shelf	NEREZ2827* 1x drawer S 1x drawer L 1x bottom shelf

HEIGHT 104 CM

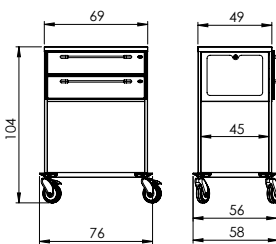

NEREZ2830* 2x drawer M 1x bottom shelf	NEREZ2831* 4x drawer S 1x bottom shelf	NEREZ2832* 2x drawer S 1x drawer M 1x bottom shelf	NEREZ2833* 1x drawer S 1x drawer L 1x bottom shelf	NEREZ2834* 2x drawer M 1x pull out basket 1x bottom shelf	NEREZ2835* 4x drawer S 1x pull out basket 1x bottom shelf

NEREZ2836* 2x drawer S 1x drawer M 1x pull out basket 1x bottom shelf	NEREZ2837* 1x drawer S 1x drawer L 1x pull out basket 1x bottom shelf	NEREZ2838* 2x drawer M 2x bottom shelf	NEREZ2839* 4x drawer S 2x bottom shelf	NEREZ2840* 2x drawer S 1x drawer M 2x bottom shelf	NEREZ2841* 1x drawer S 1x drawer L 2x bottom shelf	NEREZ2842* 2x drawer M 1x pull out basket 2x bottom shelf	NEREZ2843* 4x drawer S 1x pull out basket 2x bottom shelf

NEREZ2844* 2x drawer S 1x drawer M 1x pull out basket 2x bottom shelf	NEREZ2845* 1x drawer S 1x drawer L 1x pull out basket 2x bottom shelf	NEREZ2860* 3x drawer M 1x bottom shelf	NEREZ2861* 6x drawer S 1x bottom shelf	NEREZ2862* 4x drawer S 1x drawer M 1x bottom shelf	NEREZ2863* 2x drawer S 2x drawer M 1x bottom shelf	NEREZ2864* 1x drawer S 1x drawer M 1x drawer L 1x bottom shelf	NEREZ2865* 3x drawer S 1x drawer L 1x bottom shelf

NEREZ2866* 2x drawer L 1x bottom shelf	NEREZ2867* 3x drawer M 1x pull out basket 1x bottom shelf	NEREZ2868* 6x drawer S 1x pull out basket 1x bottom shelf	NEREZ2869* 4x drawer S 1x drawer M 1x pull out basket 1x bottom shelf	NEREZ2870* 2x drawer S 2x drawer M 1x pull out basket 1x bottom shelf	NEREZ2871* 1x drawer S 1x drawer M 1x drawer L 1x pull out basket 1x bottom shelf	NEREZ2872* 3x drawer S 1x drawer L 1x pull out basket 1x bottom shelf	NEREZ2873* 2x drawer L 1x pull out basket 1x bottom shelf

Don't you know how to select? We will be happy to advise you! Toll free: +420 800 100 798

STAINLESS STEEL PLATES - WITHOUT MODULE SYSTEM

ALL-STAINLESS STEEL DESIGN L-LINE

Cart construction, including plates, handles (if it is part of the cart) and drawers made of stainless steel AISI304.

Drawers central locking.

Self-supporting plate made of stainless steel AISI304 with frame 12 mm. Load capacity max. 50 kg.

Handles made of stainless steel AISI304.

Handles inserted to plastic clips.

For options of supply of complements, see p. 96.

4x corner bumper made of resistant (PE) plastic.

4x quality plastic caster Ø 12,5 cm, 2x brake.



Don't you know how to select? We will be happy to advise you! Toll free: +420 800 100 798

STAINLESS STEEL PLATES - WITHOUT MODULE SYSTEM

ALL-STAINLESS STEEL DESIGN L-LINE

HEIGHT 93 CM

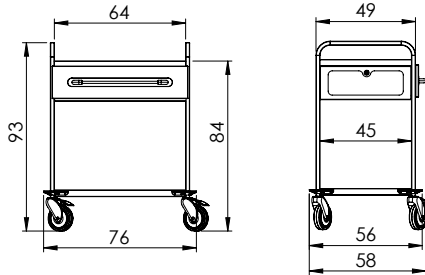

NEREZ2720NZ*

1x drawer M
1x bottom shelf



NEREZ2722NZ*

1x drawer M
1x výsuvný koš
1x bottom shelf



NEREZ2724NZ*

2x drawer M
1x bottom shelf

HEIGHT 113 CM

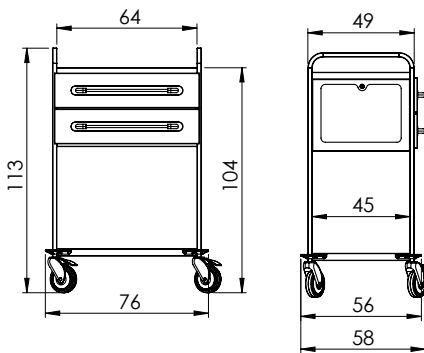

NEREZ2730NZ*

2x drawer M
1x bottom shelf



NEREZ2738NZ*

2x drawer M
2x bottom shelf



NEREZ2760NZ*

3x drawer M
1x bottom shelf

HEIGHT 84 CM

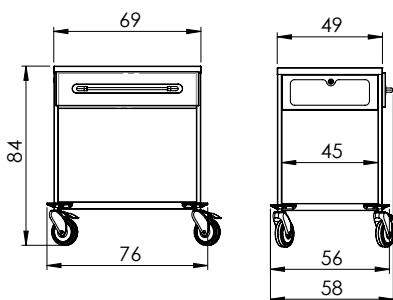

NEREZ2820NZ*

1x drawer M
1x bottom shelf

All-stainless steel
drawer M size:

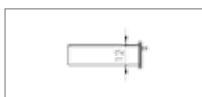









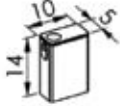

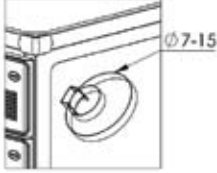



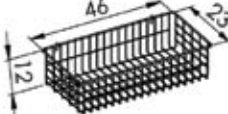

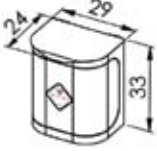
STAINLESS STEEL PLATES

COMPLEMENTS AND ACCESSORIES

L-LINE - WITH DRAWERS

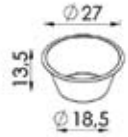
STAINLESS ST. PLATES

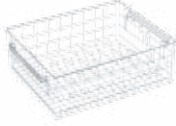
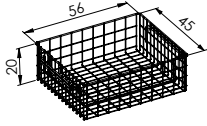
		<p>Removable vial opener</p> <p>with stainless steel AISI304 disposal container - set.</p> <p>cat. No. 5763*</p>			<p>Holder of container for used needles</p> <p>made of PVC tape with option of diameter change - set.</p> <p>cat. No. 5757*</p>
		<p>Removable stainless steel AISI304 wire basket</p> <p>- set. Load capacity: 3 kg.</p> <p>cat. No. 5764L*</p>			<p>Stainless steel AISI304 removable wire basket</p> <p>- set. Load capacity: 3 kg.</p> <p>cat. No. 5765L*</p>
		<p>Stainless steel AISI304 container for infectious waste</p> <p>removable - set. Volume: 15l.</p> <p>cat. No. 5754L*</p>			<p>Stainless steel AISI304 folding desk</p> <p>with shallow depth and protective plastic corners - set. Load capacity: 8 kg.</p> <p>cat. No. 5853ZN*</p>
		<p>Stainless steel AISI304 removable divider</p> <p>for 10 medical documentation files - set. Divider is only for the lower shelf of L-LINE plates.</p> <p>cat. No. 5789*</p>			<p>Stainless steel AISI304 removable bowl</p> <p>- set. Is placed to holder of bowl for stainless steel plates: cat. No. NEREZ0006J (profile) cat. No. NEREZ0006T (pipe)</p> <p>cat. No. 11299NM1</p>
		<p>Stainless steel AISI304 rotating holder of bowl</p> <p>with arrestment - set. For bowl cat. No. 11299NM1. Load capacity: 5 kg. ATTENTION! HOLDER IS WITHOUT BOWL! Holder for stainless steel plate with drawer.</p> <p>cat. No. NEREZ0006J*</p>			<p>Stainless steel AISI304 bottom pull out basket</p> <p>of L-LINE. Load capacity: 15 kg.</p> <p>cat. No. 01518</p>

Don't you know how to select? We will be happy to advise you! Toll free: +420 800 100 798

STAINLESS STEEL PLATES - M, L, XL, XXL

ALL-STAINLESS STEEL DESIGN L-LINE WITHOUT DRAWERS

Cart construction, including plates, handles (if it is a part of the cart) and drawers made of stainless steel AISI304.

Self-supporting plate with frame 12 mm.

Antivibration support.

4x corner or rounded bumper made of quality plastic.

Self-supporting plate made of stainless steel AISI304 with frame 12 mm. Load capacity: max. 50 kg.

Option of turnable holder with stainless steel bowl.

4x quality plastic caster Ø 12,5 cm, 2x brake.



STAINLESS ST. PLATES

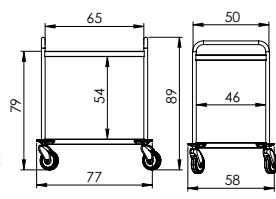

NEREZ2700*

2x plate with frame
total load capacity: 100 kg

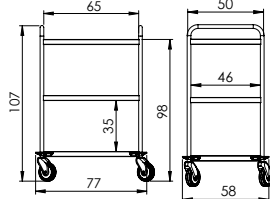

NEREZ2701*

3x plate with frame
total load capacity: 150 kg

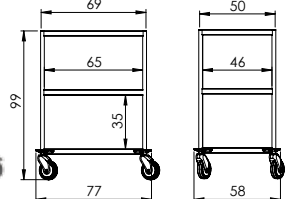

NEREZ2702*

3x plate with frame
total load capacity: 150 kg

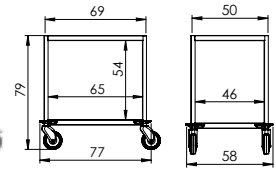

NEREZ2703*

2x plate with frame
total load capacity: 100 kg

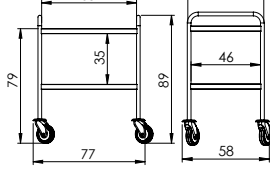

NEREZ2704*

2x plate with frame
total load capacity: 100 kg

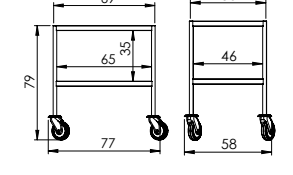

NEREZ2705*

2x plate with frame
total load capacity: 100 kg



Stainless steel AISI304
removable bowl

- set.
It is placed to holder of bowl for
stainless steel plates:
cat. No. NEREZ0006J (profile)
cat. No. NEREZ0006T (pipe)

cat. No. 11299NM1



Stainless steel AISI304
rotating holder of bowl

- with arrestment - set. For bowl
cat. No. 11299NM1.
Load capacity: 5 kg.
ATTENTION! HOLDER IS WITHOUT
BOWL!
Holder for stainless steel plates
without drawers.

cat. No. NEREZ0006T*

Don't you know how to select? We will be happy to advise you! Toll free: +420 800 100 798

STAINLESS STEEL PLATES - M, L, XL, XXL

WITHOUT DRAWERS M-LINE

Self-supporting plate. Even load according to the individual type of cart.

Cart construction, including plates, made of stainless steel AISI304.

Antivibration support.

4x corner or rounded bumper made of quality plastic.



STAINLESS ST. PLATES

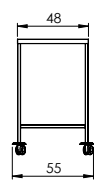
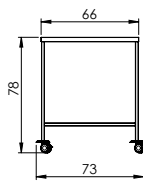

NEREZ2051*

1x flat plate - even load: max. 30 kg
4x swivel plastic caster Ø 6,5 cm, 2x brake.
Total load capacity: 30 kg.

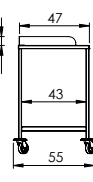
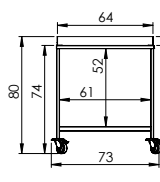

NEREZ2053*

1x plate with removable sides, 1x flat plate
even load: max. 40 kg
4x swivel plastic caster Ø 7,5 cm, 2x brake.
Total load capacity: 80 kg.

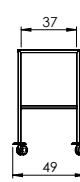
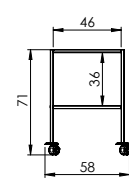

NEREZ2054*

cart construction: powder coating
plates made of stainless steel AISI304
1x removable plate with frame, 1x flat fixed plate
even load: max. 20 kg
4x swivel plastic caster Ø 6,5 cm, 2x brake
Total load capacity: 40 kg.

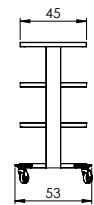
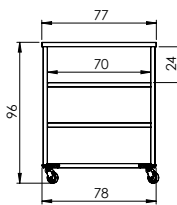

NEREZ2031*

1x flat desktop, 3x flat plate - even load: max. 10 kg
4x swivel plastic caster Ø 7,5 cm, 2x brake
Total load capacity: 40 kg.

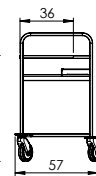
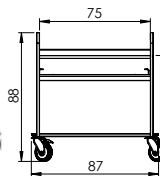

NEREZ2005*

Stainless steel plate for tea vessels
1x upper plate, 1x lower plate (under trough)
1x removable dripping trough with grid
4x swivel plastic caster Ø 12,5 cm, 2x brake
2x pushing handle

- even load of upper desktop - max. 70 kg
- even load in dripping trough max: 15 kg
- even load of tray under trough max: 30 kg
2x corner and round bumper made of quality plastic
total load capacity: 80 kg

Don't you know how to select? We will be happy to advise you! Toll free: +420 800 100 798

STAINLESS STEEL PLATES - M, L, XL, XXL

ALL-STAINLESS STEEL DESIGN - WITHOUT DRAWERS

XL-LINE

Self-supporting plate with frame 12 mm.
Even load: max. 50 kg.

Antivibration support.

4x corner or rounded bumper
made of quality plastic.

Cart construction, including plates, handles (if it is a part of the cart) and baskets made of stainless steel AISI304.

4x quality plastic caster Ø 12,5 cm,
2x brake.

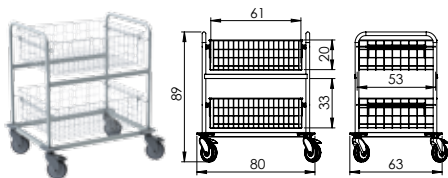

NEREZ2603*

2x pull out basket
total load capacity: 30 kg

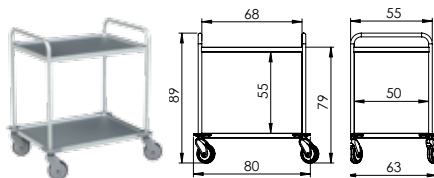

NEREZ2601*

2x plate with frame
total load capacity: 100 kg

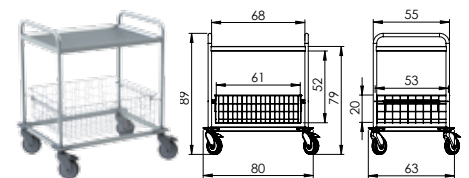

NEREZ2602*

1x plate with frame, 1x pull out basket
total load capacity: 65 kg

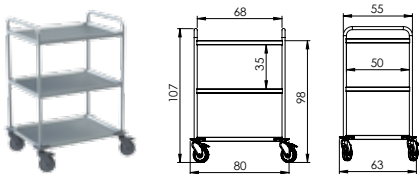

NEREZ2603*

3x plate with frame
total load capacity: 150 kg

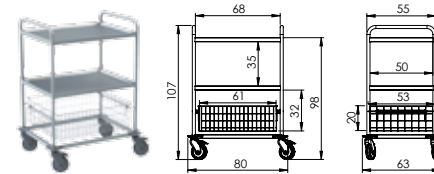

NEREZ2604*

2x plate with frame, 1x pull out basket
total load capacity: 115 kg

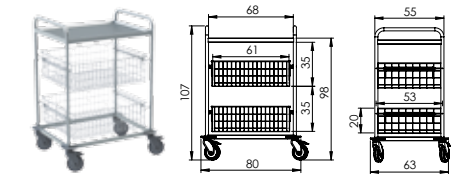

NEREZ2605*

1x plate with frame, 2x pull-out basket
total load capacity: 80 kg

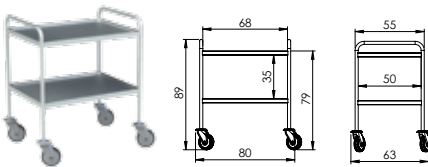

NEREZ2606*

2x plate with frame
total load capacity: 100 kg

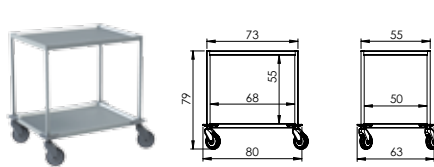

NEREZ2611*

2x plate with frame
total load capacity: 100 kg

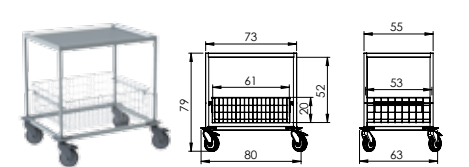

NEREZ2612*

1x plate with frame, 1x pull out basket
total load capacity: 65 kg

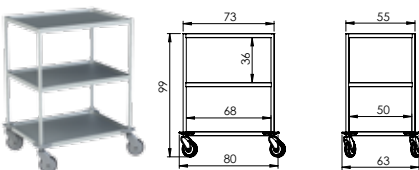

NEREZ2613*

3x plate with frame
total load capacity: 150 kg

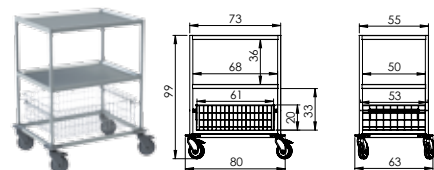

NEREZ2614*

2x plate with frame, 1x pull-out basket
total load capacity: 115 kg

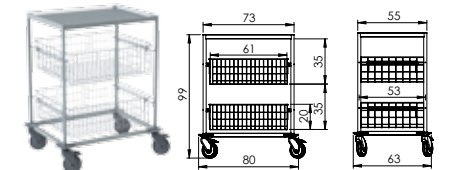

NEREZ2615*

1x plate with frame, 2x pull out basket
total load capacity: 80 kg

Don't you know how to select? We will be happy to advise you! Toll free: +420 800 100 798

STAINLESS STEEL PLATES - M, L, XL, XXL

ALL-STAINLESS STEEL DESIGN - WITHOUT DRAWERS

XL-LINE

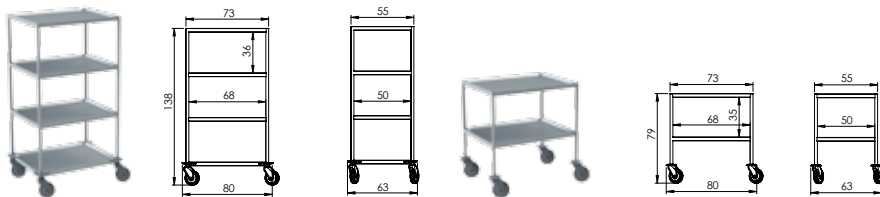

NEREZ2616*

4x plate with frame
total load capacity: 200 kg

NEREZ2617*

2x plate with frame
total load capacity: 100 kg

STAINLESS ST. PLATES

		<p>Stainless steel AISI304 removable bowl</p> <p>- set. It is placed to holder of bowl for stainless steel plates: cat. No. NEREZ0006J (profile) cat. No. NEREZ0006T (pipe)</p> <p>cat. No. 11299NM1</p>			<p>Stainless steel AISI304 rotating holder of bowl</p> <p>with arrestment - set. For bowl cat. No. 11299NM1. Load: 5 kg. ATTENTION! HOLDER WITHOUT BOWL! Holder for stainless steel plates without drawers.</p> <p>cat. No. NEREZ0006T*</p>
-----------------------------------------------------------------------------------	-----------------------------------------------------------------------------------	----------------------------------------------------------------------------------------------------------------------------------------------------------------------------------------------------------------------	-----------------------------------------------------------------------------------	-------------------------------------------------------------------------------------	---------------------------------------------------------------------------------------------------------------------------------------------------------------------------------------------------------------------------------------------------------

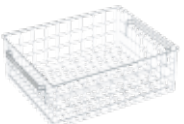
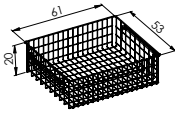
		<p>Stainless steel AISI304 wire bottom basket</p> <p>for XL-LINE. Load: 15 kg.</p> <p>cat. No. 01514</p>
-------------------------------------------------------------------------------------	-------------------------------------------------------------------------------------	--------------------------------------------------------------------------------------------------------------

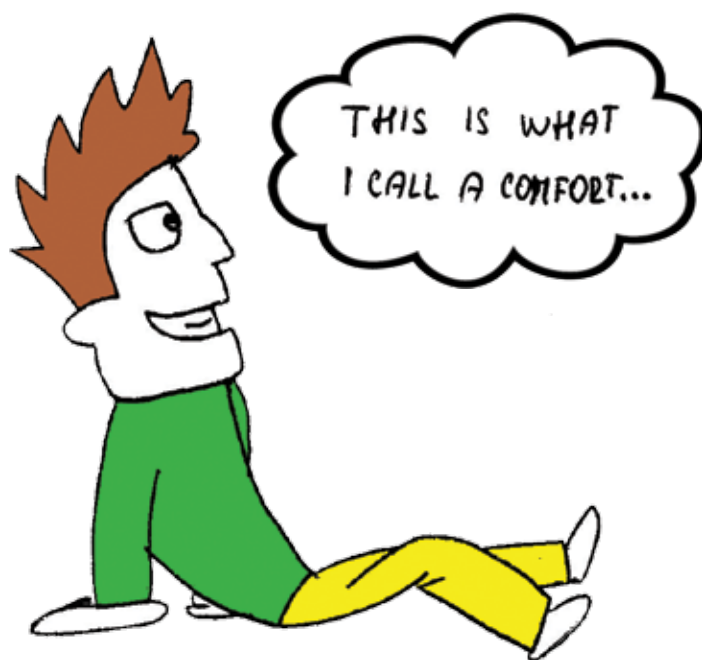

Don't you know how to select? We will be happy to advise you! Toll free: +420 800 100 798

STAINLESS STEEL PLATES - M, L, XL, XXL

ALL-STAINLESS STEEL DESIGN - WITHOUT DRAWERS XXL-LINE

Cart construction, including plates and handles (if it is a part of the cart) made of stainless steel AISI304.

Option of rotatable holder with stainless steel bowl.

4x quality plastic caster \varnothing 12,5 cm, 2x brake.

Self-supporting plate with frame 12 mm, even load according to the individual type of cart.

Antivibration support.

4x corner or rounded bumper made of quality plastic.

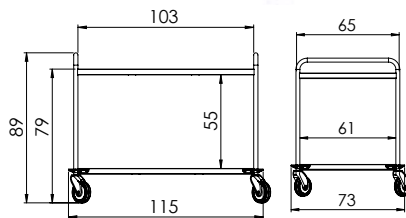

NEREZ2061*

2x plate with frame - even load: max. 100 kg
total load capacity: 200 kg

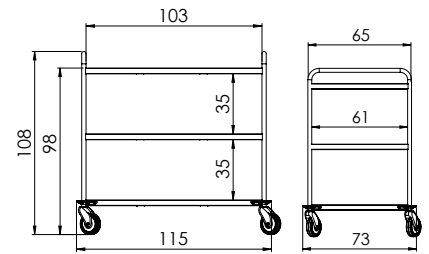

NEREZ2062*

3x plate with frame - even load: max. 100 kg
total load capacity: 300 kg

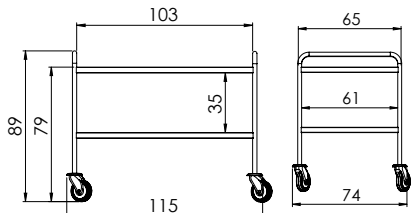

NEREZ2063*

2x plate with frame - even load: max. 50 kg
total load capacity: 100 kg

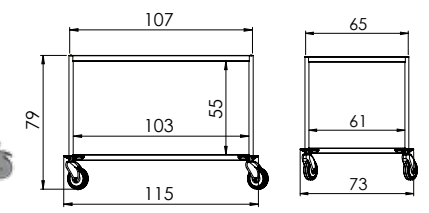

NEREZ2064*

2x plate with frame - even load: max. 100 kg
total load capacity: 200 kg

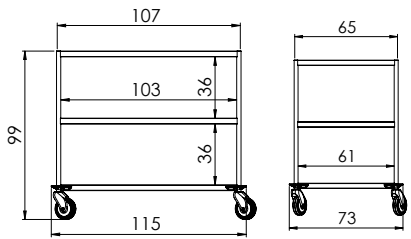

NEREZ2065*

3x plate with frame - even load: max. 100 kg
total load capacity: 300 kg

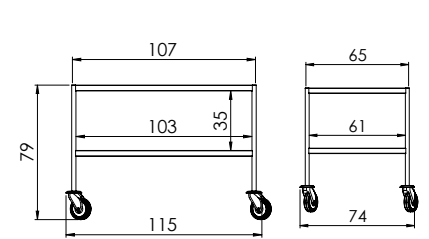

NEREZ2066*

2x plate with frame - even load: max. 50 kg
total load capacity: 100 kg

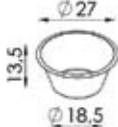

Stainless steel AISI304 removable bowl

- set.
It is placed to holder of bowl for stainless steel plates:
cat. No. NEREZ0006J (profile)
cat. No. NEREZ0006T (pipe)

cat. No. 11299NM1



Stainless steel AISI304 rotating holder of bowl

with arrestment - set. For bowl cat. No. 11299NM1.
Load capacity: 5 kg.
ATTENTION! HOLDER IS WITHOUT BOWL!
Holder for stainless steel plates without drawer.

cat. No. NEREZ0006T*

Don't you know how to select? We will be happy to advise you! Toll free: +420 800 100 798

HEALTHCARE FURNITURE

INSTRUMENTATION CARTS

HYDRAULIC ELEVATION

NEREZ1113*



NEREZ1114*



NEREZ1120*



NEREZ1125*



PNEUMATIC ELEVATION

NEREZ1130*



NEREZ1135*



NEREZ1101*



MANUAL ELEVATION

Don't you know how to select? We will be happy to advise you! Toll free: +420 800 100 798

INSTRUMENTATION CARTS - MAYO INSTRUMAN HYDRAULIC TOP I

NEREZ1113* - width 80 x depth 56 x height 90 - 130 cm

Sterilization: max. 130°C by steam for 3 minutes.

Desktop with frame 1,2 cm and turnable by 360° with the arrestment. Removable and portable. Even load: max. 50 kg.

Hydraulic elevation - hydraulics with specially developed telescope. Hydraulic telescope is protected against leaking of the hydraulic liquid and being overturned.

Minimum height 90 cm - maximum height 130 cm. Elevation by 40 cm.

All-stainless steel Y-shaped design of the undercart made of stainless steel AISI304.

Cart construction made of stainless steel AISI304 including the desktop.

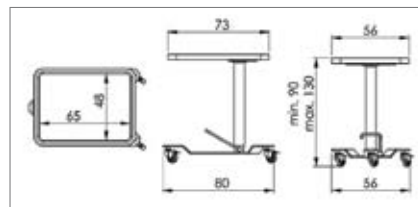

Cart antistatic design.

3x stainless steel caster Ø 7,5 cm with brake.

TOP Hydraulic cart is appreciated by healthcare workers mainly due to its comfortable operation and the elegant design. During work, you can use a specially developed telescope allowing not only desktop sensitive elevation, but also an above average change of its height up to 40 cm. A larger desktop with a deeper working area ensures a safe deposit of objects.

TOP Hydraulic cart is an outstanding product and you will surely appreciate the comfort it provides for a healthcare facility and that your specialized work deserves.

	Working desktop can be easily removed at any time.		Stop lever of the turnable working desktop arrest.		Depth of the stainless desktop is 12 mm.
	Elevation: Stepping on the foot pedal elevates the desktop up to the max. height of 130 cm from the floor.		Lowering: Elevating the foot pedal continuously lowers the desktop down to the minimum height of 90 cm from the floor.		Foot pedal allowing a continuous and sensitive elevation of the working desktop by 40 cm.

Don't you know how to select? We will be happy to advise you! Toll free: +420 800 100 798

HEALTHCARE FURNITURE

INSTRUMENTATION CARTS - MAYO INSTRUMAN HYDRAULIC TOP II

NEREZ1114* - width 73 x depth 56 x height 90 - 130 cm

Sterilization: max. 130°C by steam for 3 minutes.

Desktop with frame 1,2 cm and turnable by 90° with arrestment to both directions. Removable and portable. Even load: max. 50 kg.

Hydraulic elevation - hydraulics with specially developed telescope. Hydraulic telescope is protected against leaking of the hydraulic liquid and being overturned.

Minimum height 90 cm - maximum height 130 cm. Elevation by 40 cm.

All-stainless steel T-shaped desing of the undercart made of stainless steel AISI304.

Cart construction, including the desktop, made of stainless steel AISI304.

Cart antistatic design.

3x stainless steel caster Ø 7,5 cm with brake.

TOP Hydraulic cart is appreciated by healthcare workers mainly due to its comfortable operation and the elegant design. During work, you can use a specially developed telescope allowing not only desktop sensitive elevation, but also an above average change of its height up to 40 cm. A larger desktop with a deeper working area ensures a safe deposit of objects.

TOP Hydraulic cart is an outstanding product and you will surely appreciate the comfort it provides for a healthcare facility and that your specialized work deserves.

	Working desktop can be easily removed at any time.		Stop lever of the turnable working desktop arrest.		Depth of the stainless desktop is 12 mm.
	Elevation: Stepping on the foot pedal elevates the desktop up to the max. height of 130 cm from the floor.		Lowering: Elevating the foot pedal continuously lowers the desktop down to the minimum height of 90 cm from the floor.		Foot pedal allowing a continuous and sensitive elevation of the working desktop by 40 cm.

Don't you know how to select? We will be happy to advise you! Toll free: +420 800 100 798

INSTRUMENTATION CARTS - MAYO INSTRUMAN HYDRAULIC CLASSIC

NEREZ1120* - width 66 x depth 48 x height 90 - 130 cm



INSTRUMAN LINE

Classic Hydraulic cart is appreciated by healthcare workers because of its high functionality and easy operation during work. This is allowed e.g. by hydraulic elevation and a turnable and removable desktop.

Classic Hydraulic cart will make your demanding work at your facility easier.

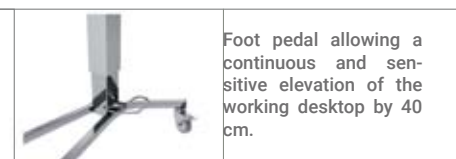
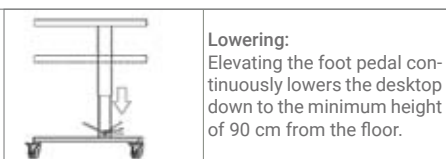
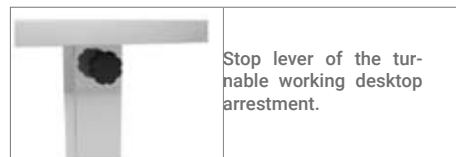
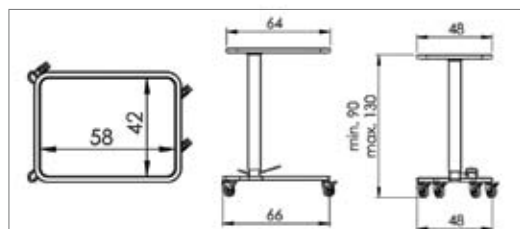

Don't you know how to select? We will be happy to advise you! Toll free: +420 800 100 798

HEALTHCARE FURNITURE

INSTRUMENTATION CARTS - MAYO INSTRUMAN MAXI

NEREZ1125* - width 109 x depth 67 x height 90 - 130 cm



MAXI Hydraulic cart provides comfort to your work at the healthcare facility that your specialized work deserves.

Because of its large desktop with an elevated edge and an increased load, MAXI Hydraulic cart allows you to place aside a larger amount of healthcare material and tools, which increases flexibility during your work. Easy operation during work is provided by the hydraulic elevation.

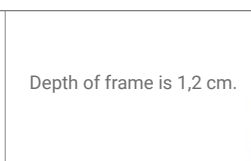
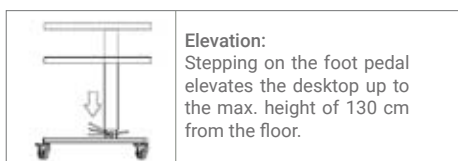
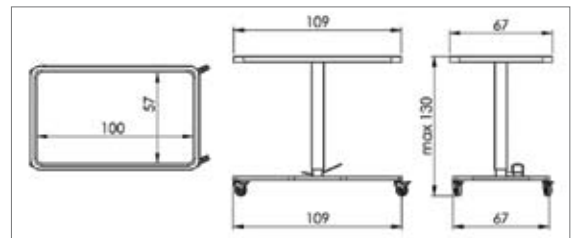
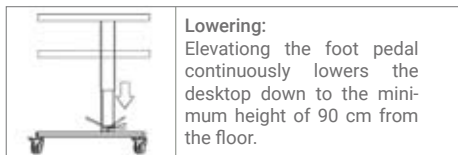

Don't you know how to select? We will be happy to advise you! Toll free: +420 800 100 798

INSTRUMENTATION CARTS - MAYO INSTRUMAN PNEUMATIC SPRING

NEREZ1130* - width 66 x depth 48 x height 90 - 130 cm

Sterilization: max. 130°C by steam for 3 minutes.

Desktop turnable by 360° with shallow depth and arrestment. Removable and portable. Even load: max. 20 kg.

Pneumatic elevation.

Minimum height 90 cm - maximum height 130 cm.

Elevation by 40 cm.

All-stainless steel design of the undercart made of stainless steel AISI304.

Cart construction, including the desktop, made of stainless steel AISI304.

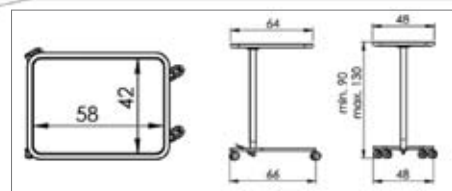

4x plastic caster Ø 6,5 cm with brake.

When working with the Pneumatic Spring cart, you will appreciate the easy operation at the changed height because of the gas spring. Turnable and removable desktop allows flexibility during your work. Pneumatic Spring cart meets demanding requirements of healthcare work.



Working desktop can be easily removed and washed thoroughly at any time.



Stop lever of the turnable working top arrestment.

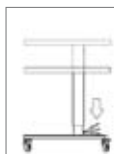

Elevation: Using the gas spring allows cont. elev. of the working top upward when stepping on the foot pedal (up to the 130 cm from the floor). When releasing the pedal, the working top stops at the desired height.

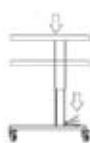

Lowering: Elevating the foot pedal continuously lowers the top down to the minimum height 90 cm from the floor.



Foot pedal allowing a continuous and sensitive elevation of the working top by 40 cm.

Don't you know how to select? We will be happy to advise you! Toll free: +420 800 100 798

HEALTHCARE FURNITURE

INSTRUMENTATION CARTS - MAYO INSTRUMAN HAND TWIST

NEREZ1135* - width 66 x depth 48 x height 90 - 130 cm

Sterilization: max. 130°C by steam for 3 minutes.

Desktop turnable by 360° with shallow depth and arrestment. Removable and portable. Load: max. 20 kg.

Minimum height 90 cm - maximum height 130 cm. Elevation by 40 cm.

Manual elevation.

Cart construction, including the desktop, made of stainless steel AISI304.

All-stainless steel design of the undercart made of stainless steel AISI304.

4x plastic casterØ 6,5 cm with brake.

Mayo Instruman Hand Twist is an ideal compromise for healthcare facilities. It provides a turnable, removable and easily sterilised desktop with adjustable height and weight 20 kg.

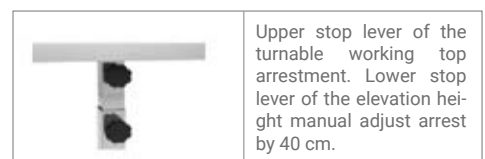
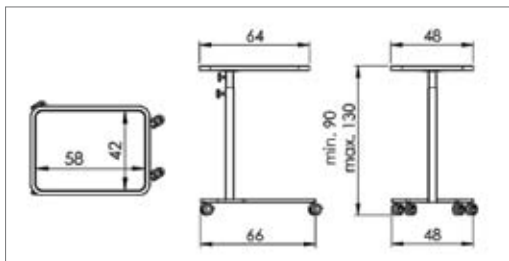

Don't you know how to select? We will be happy to advise you! Toll free: +420 800 100 798

INSTRUMENTATION CART - MAYO INSTRUMAN HAND

NEREZ1101* - width 64 x depth 48 x height 65 - 100 cm

Sterilization: max. 130°C by steam for 3 minutes.

Desktop with shallow depth.
Even load: max. 10 kg.

Minimum height 65 cm - maximum height 100 cm.
Elevation by 35 cm.

Manual elevation.

All-stainless steel design of undercart made of stainless steel AISI304.

Cart construction, including the desktop made of stainless steel AISI304.

4x plastic caster Ø 6,5 cm, 2x with brake.



Mayo Instruman Hand is the economic solution while maintaining functionality and height adjustment of the desktop according to your needs. Mayo Instruman Hand cart meets demanding requirements of healthcare work.

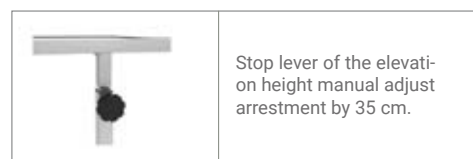
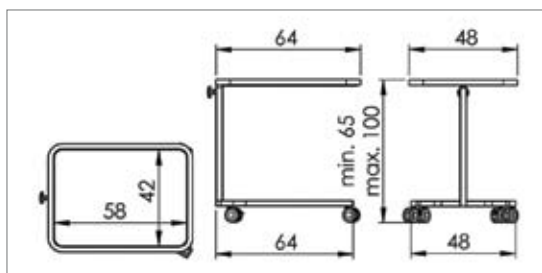

Don't you know how to select? We will be happy to advise you! Toll free: +420 800 100 798

HEALTHCARE FURNITURE

HEALTHCARE FURNITURE FOR INFECTIOUS WASTE

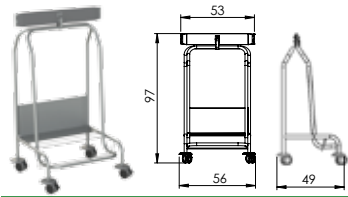

NEREZ4001*

4x swivel caster Ø 6,5 cm
2x brake

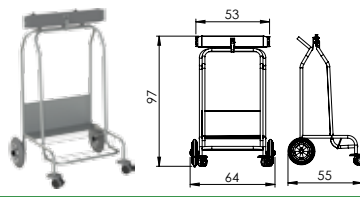

NEREZ4002*

2x fixed caster Ø 20 cm and swivel caster
Ø 6,5 cm, 2x brake

- all-stainless steel design of the cart construction made of stainless steel AISI304
- highly resistant and quality rubber holder
- for bags of 80l volume
- round plastic bumpers at each caster Ø 6,5 cm
- total load capacity: 40 kg

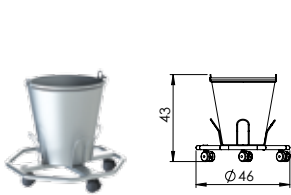

NEREZ1015*

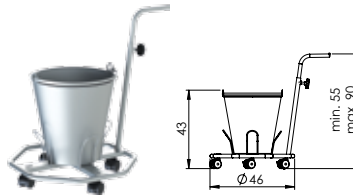

NEREZ1016*

push handle with adjustable height

- cart construction, including the bucket and peripheral rim made of stainless steel AISI304
- Ø 30 cm bucket, volume: 15l
- 4x swivel caster Ø 5 cm, 2x brake
- total load capacity: 15 kg

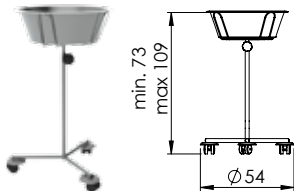

NEREZ1010*

Ø 38 cm, volume 11l
3x swivel caster

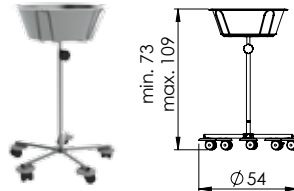

NEREZ1011*

Ø 38 cm, volume 11l
5x swivel caster, 2x brake

- all-stainless steel design of the construction made of stainless steel AISI304
- continuously adjustable height of the stand with arrestment
- swivel caster Ø 5 cm
- round plastic bumpers at each caster

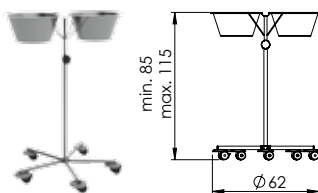

NEREZ1012*

2x Ø 27 cm, volume 5l
5x swivel caster, 2x brake

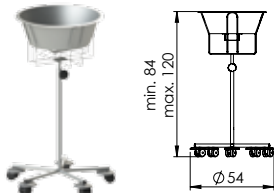

NEREZ1013*

Ø 38 cm, volume 11l - bowl with handle on the bottom side, 5x swivel caster, 2x brake

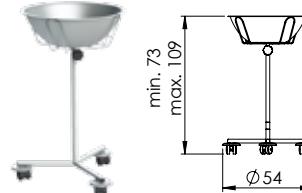

NEREZ1009*

Ø 38 cm, volume 11l - antirust surface treatment, 3x swivel caster

SPARE BOWLS AND BUCKETS



- Ø 27 cm, volume 5l
- stainless steel AISI304
- spare bowl for NEREZ1012*

cat. No. 11299NM1

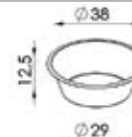

- Ø 38 cm, volume 11l
- stainless steel AISI304
- spare bowl for NEREZ1010* and NEREZ1011*

cat. No. 11299NM2



- Ø 38 cm, volume 11l with handle
- stainless steel AISI304
- spare bowl for NEREZ1013*

cat. No. NEREZ0005



- Ø 38 cm, volume 11l
- antirust surface treatment
- spare bowl for NEREZ1009*

cat. No. 00056B



- Ø 30 cm, volume 15l
- stainless steel AISI304
- spare bucket for NEREZ1015* and NEREZ1016*

cat. No. 11299NV1

Don't you know how to select? We will be happy to advise you! Toll free: +420 800 100 798

INFUSION STANDS AND HOLDERS

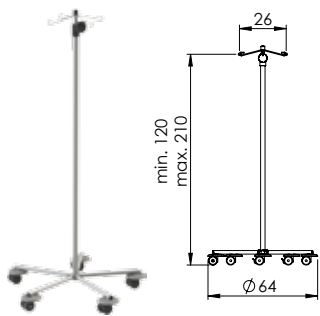

NEREZ1002*

4x hook - 1 hook load: max. 4 kg
5x swivel caster Ø 5 cm, 2x brake
antistatic design
total load capacity: 16 kg

NEREZ1005*

stand to hang pumps
4x hook - 1 hook load: max. 4 kg
strengthened support for higher load
5x swivel caster Ø 6,5 cm, 2x brake
antistatic design
total load capacity: 40 kg

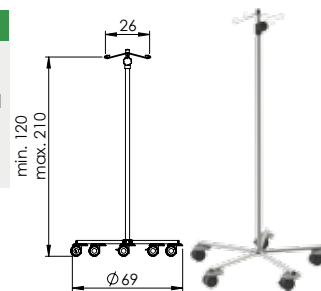

- all-stainless steel design of stand construction made of stainless steel AISI304
- swivel casters with round plastic bumpers
- continuously adjustable cross holder height

10046S5*

stand economic use
4x hook - 1 hook load: max. 3 kg
stand - komaxit paint
pull out part - chrome
5x swivel caster Ø 5 cm
total load capacity: 12 kg

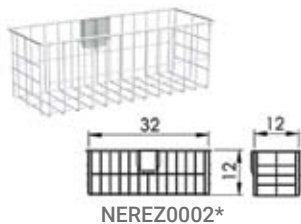
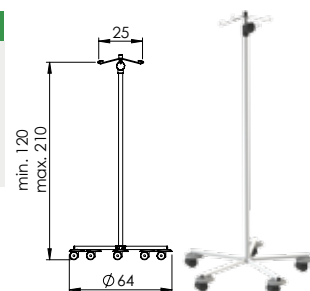

NEREZ0002*

Deposit basket for infusion stand.

Design made of stainless steel AISI304. Continuously adjustable basket height with arrestment. Load capacity: 2 kg.

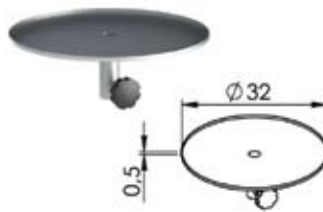

NEREZ0003*

Deposit tray for infusion stand.

Design made of stainless steel AISI304. Continuously adjustable tray height with arrestment. Load capacity: 3 kg.

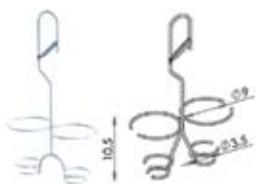

00081NDH (s/s AISI304)
00081DH (chrome)

Double holder of bar for infusion bottles.



00083SN (s/s AISI304)

Holder of permanent catheter bag.



00081NSH (s/s AISI304)
00081SH (chrome)

Holder of infusion bags to the bar.



00081NU (s/s AISI304)

Universal holder for the bar.

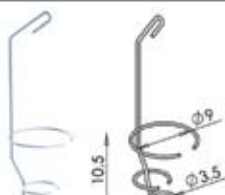

00081N (s/s AISI304)
00081 (chrome)

Holder for infusion bottles.

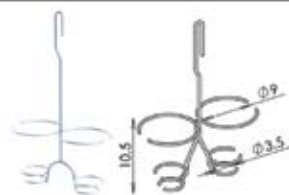

00081ND (s/s AISI304)
00081D (chrome)

Double holder for infusion bottles.



00083NA (s/s AISI304)
00083A (chrome)

Holder for urine bottles.



00081NH (s/s AISI304)
00081H (chrome)

Holder for infusion bottles to the bar.

Don't you know how to select? We will be happy to advise you! Toll free: +420 800 100 798

HEALTHCARE FURNITURE

MOBILE STAINLESS STEEL STANDS

3 types of bucket sizes.
Even load: max. 3 kg.

All-stainless steel design of the stand construction
made of stainless steel AISI304.

01511

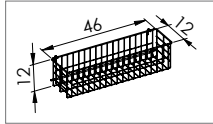

01512

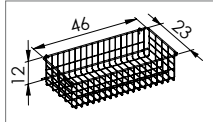

01513

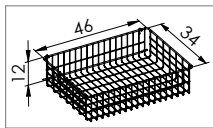

All-stainless steel design of baskets made of
stainless steel AISI304.

Bottom or upper shelf (if it is a part of the cart)
made of stainless steel AISI304.
Even load: max. 5 kg.

4x corner plastic bumper.

4x plastic swivel caster Ø 7,5 cm, 2x brake.

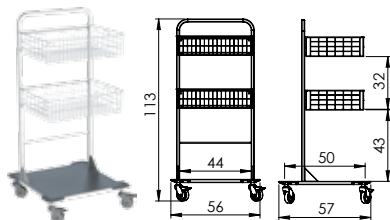

NEREZ5001*

2x hanging basket 01513
1x bottom shelf
total load capacity: 11 kg

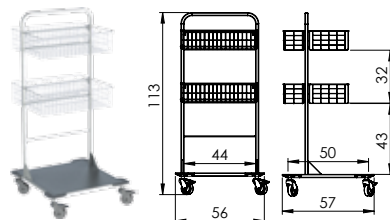

NEREZ5002*

2x hanging basket 01511, 2x 01512
1x bottom shelf
total load capacity: 17 kg

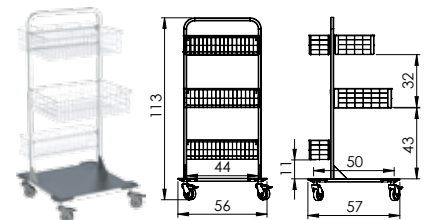

NEREZ5003*

2x hanging basket 01511, 1x 01512, 1x 01513
1x bottom shelf
total load capacity: 17 kg

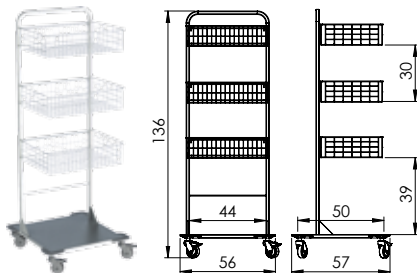

NEREZ5004*

3x hanging basket 01513
1x bottom shelf
total load capacity: 14 kg

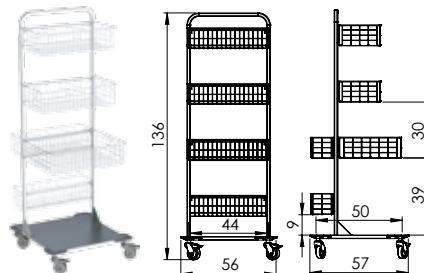

NEREZ5005*

2x hanging basket 01511, 2x 01512, 1x 01513
1x bottom shelf
total load capacity: 20 kg

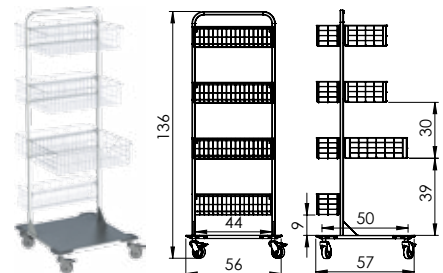

NEREZ5006*

4x hanging basket 01511, 2x 01512, 1x 01513
1x bottom shelf
total load capacity: 26 kg

Don't you know how to select? We will be happy to advise you! Toll free: +420 800 100 798

MOBILE STAINLESS STEEL STANDS

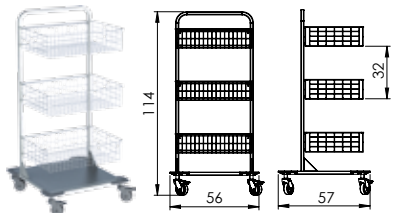

NEREZ5007*

3x hanging basket 01513
1x bottom shelf
total load capacity: 14 kg

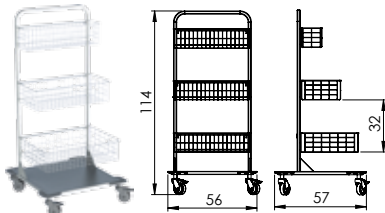

NEREZ5008*

1x hanging basket 01511, 1x 01512, 1x 01513
1x bottom shelf
total load capacity: 14 kg

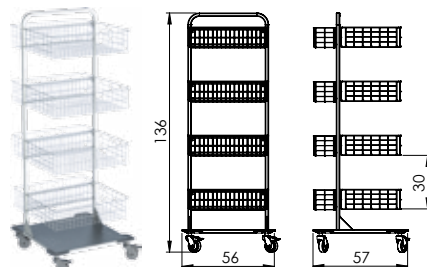

NEREZ5009*

4x hanging basket 01511, 4x 01513
1x bottom shelf
total load capacity: 29 kg

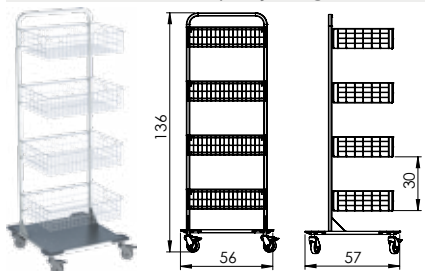

NEREZ5010*

4x hanging basket 01513
1x bottom shelf
total load capacity: 17 kg

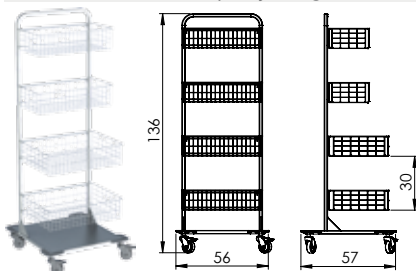

NEREZ5011*

2x hanging basket 01512, 2x 01513
1x bottom shelf
total load capacity: 17 kg

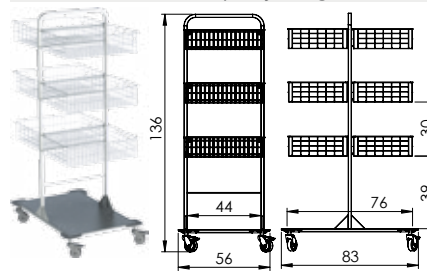

NEREZ5012*

6x hanging basket 01513
1x bottom shelf
total load capacity: 23 kg

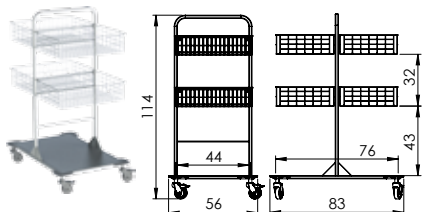

NEREZ5013*

4x hanging basket 01513
1x bottom shelf
total load capacity: 17 kg

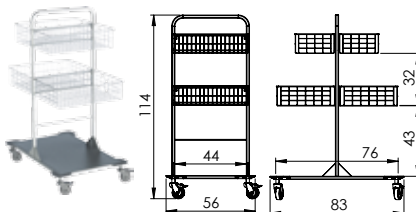

NEREZ5014*

2x hanging basket 01512, 2x 01513
1x bottom shelf
total load capacity: 17 kg

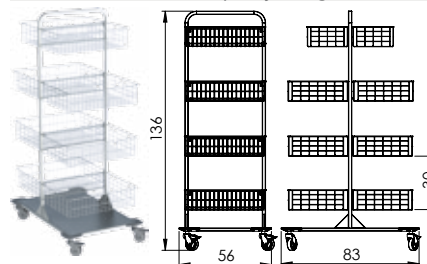

NEREZ5015*

2x hanging basket 01512, 6x 01513
1x bottom shelf
total load capacity: 29 kg

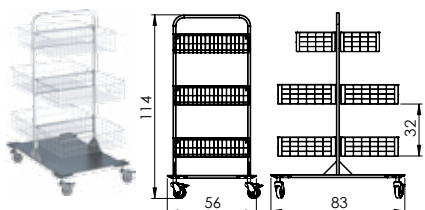

NEREZ5016*

2x hanging basket 01512, 4x 01513
1x bottom shelf
total load capacity: 23 kg

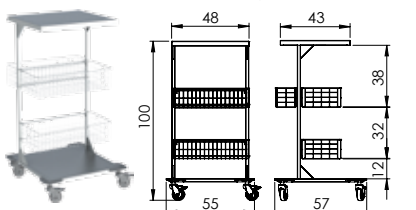

NEREZ5017*

1x upper shelf, 1x bottom shelf
1x hanging basket 01511, 2x 01512
total load capacity: 19 kg

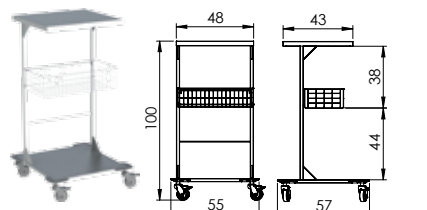

NEREZ5018*

1x upper shelf, 1x bottom shelf
1x hanging basket 01512
total load capacity: 13 kg

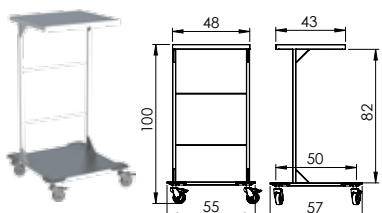

NEREZ5019*

1x upper shelf, 1x bottom shelf
total load capacity: 10 kg

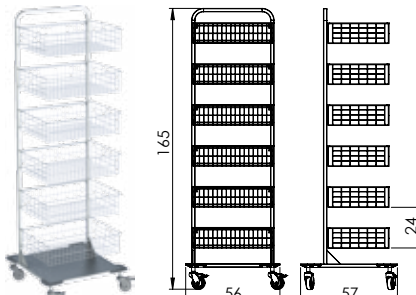

NEREZ5020*

6x hanging basket 01513
1x bottom shelf
total load capacity: 23 kg

Don't you know how to select? We will be happy to advise you! Toll free: +420 800 100 798

HEALTHCARE FURNITURE

HANGING RACK SYSTEM AND STEPS

- all-stainless steel design of the construction, including baskets made of stainless steel AISI304
- hanging hooks, including the connection material
- 3 types of basket sizes, basket even load: 6 kg:



NEREZ5101*

4x hanging basket 01513S
total load capacity: 24 kg

NEREZ5102*

4x hanging basket 01512S
total load capacity: 24 kg

NEREZ5103*

2x hanging basket 01512S, 2x
01513S, total load capacity: 24 kg

01511S

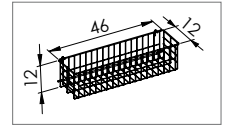

01512S

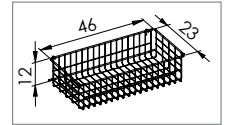

01513S

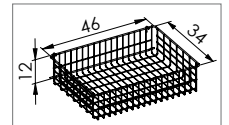

NEREZ5104*

2x hanging basket 01512S
total load capacity: 12 kg



NEREZ5105*

3x hanging basket 01511S
total load capacity: 18 kg

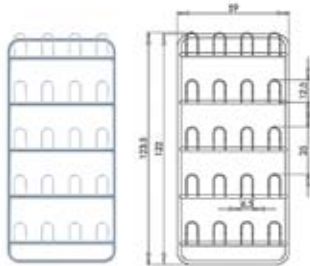

NEREZ5090*

design for 10 pairs of shoes

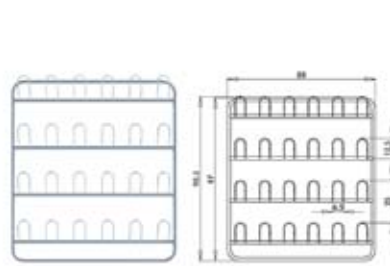

NEREZ5091*

design for 12 pairs of shoes

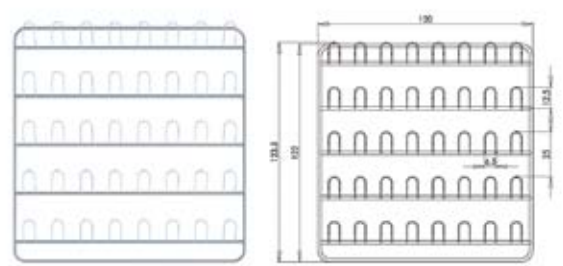

NEREZ5092*

design for 20 pairs of shoes



NEREZ1041*

1-stage step on legs

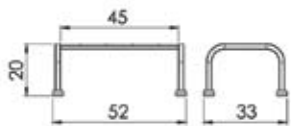

NEREZ1043*

1-stage step
4x swivel caster Ø 5 cm
pressure brake

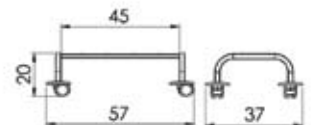

NEREZ1042*

2-stage step on legs

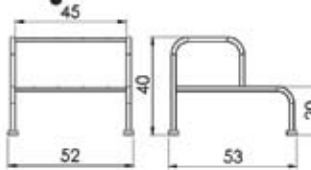

NEREZ1044*

2-stage step
4x swivel caster Ø 5 cm
pressure brake

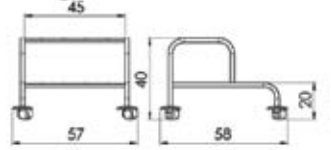

Stainless steel AISI304 construction of steps.
Steps are equipped with anti-slip treatment.
Maximum load capacity: 110 kg.

Option of load adjustment for higher weight according to customer's need.

Don't you know how to select? We will be happy to advise you! Toll free: +420 800 100 798

STAINLESS STEEL STANDS AND HOLDERS FOR MASKS AND X-RAY APRONS, INFANT CART

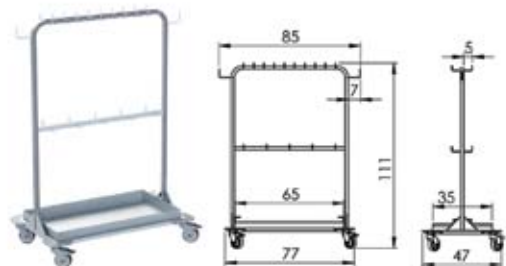

NEREZ1035*

32x hook for masks

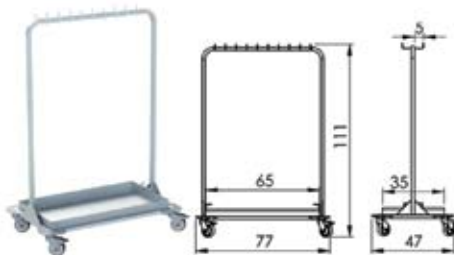

NEREZ1036*

20x hook for masks

- stainless steel AISI304 hooks for masks
- 1 hook load: 0,5 kg
- stand construction, including the tub made of stainless steel AISI304
- removable tub to make the used material handling easier
- tub load: 15 kg
- 4x swivel caster \varnothing 7,5 cm, 2x brake
- 4x corner plastic bumper

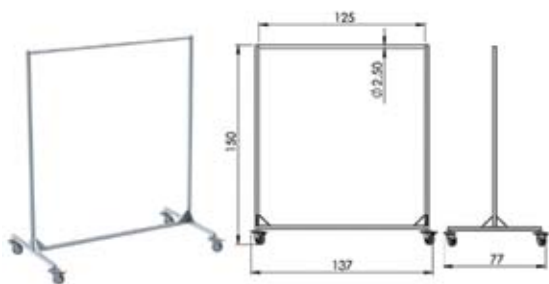

NEREZ1060*

rack for X-ray aprons

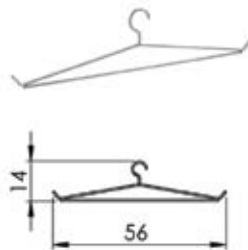

01060

hanging hanger for NEREZ1060* - load: 20 kg
made of stainless steel AISI304

- rack construction made of stainless steel AISI304
- rack even load: max. 150 kg
- antistatic design
- 4x stainless steel swivel caster \varnothing 7,5 cm, 2x brake
- 4x rounded plastic bumper



NEREZ0004*

wall holder for X-ray aprons - including the connection material made of stainless steel AISI304
total load capacity: 25 kg

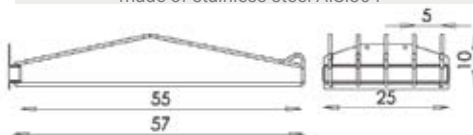

- cart construction: steel, surface treatment: powder coating
- single level load: 50 kg
- 4x swivel plastic caster \varnothing 12,5 cm, 2x brake
- 8x plastic corner bumper for better safety
- total load capacity: 100 kg



ATYPK178

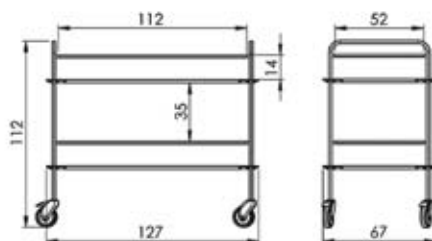

ATYPICAL PRODUCTION

CABINETS

We also offer atypical fixed room equipment consisting of different types of means of storage. This includes single door or two-door cabinets equipped with fixed or adjustable shelves and cabinets for specific purpose, usch as urinals, under vessels, endoscopes, etc.



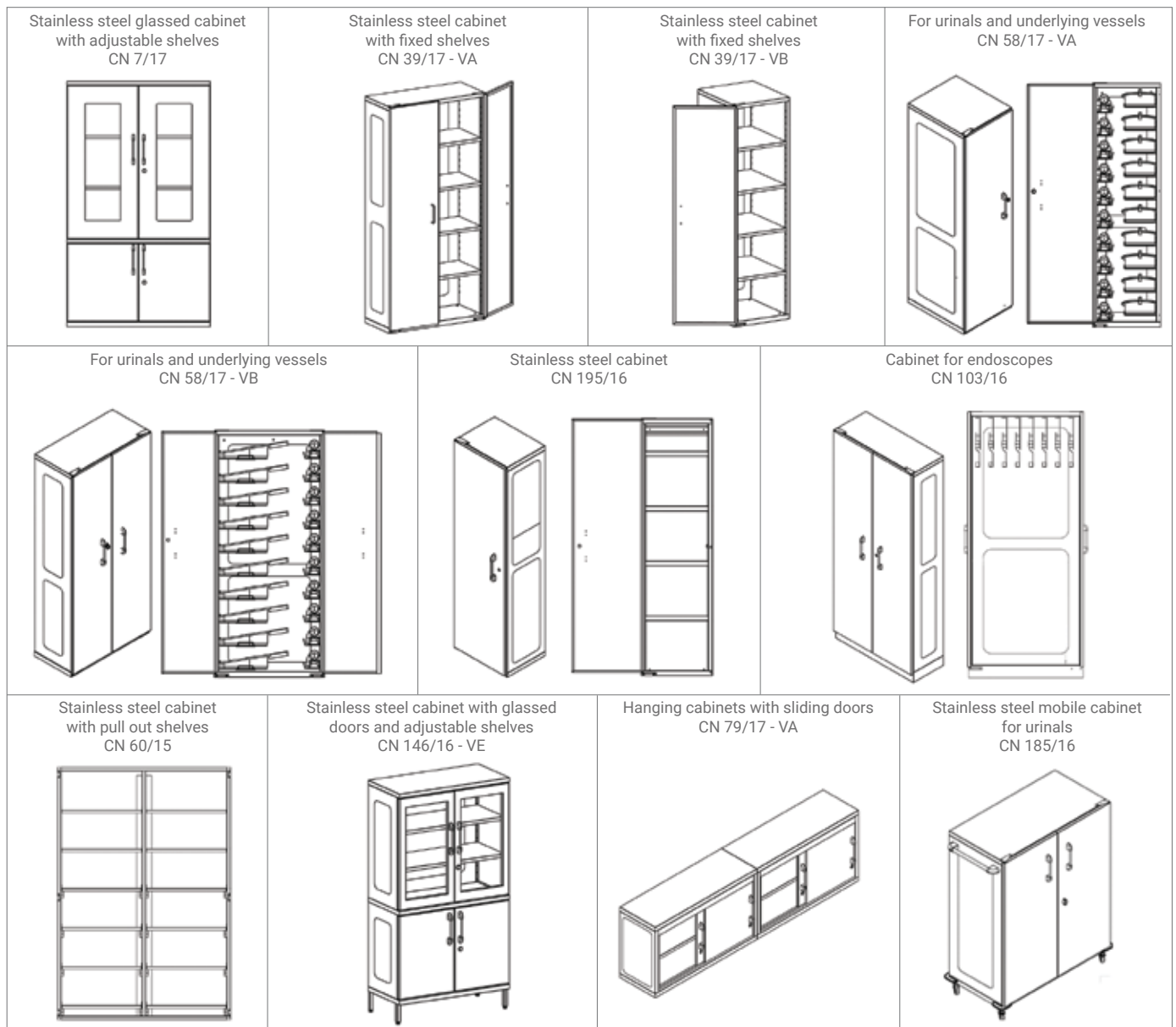



We produce hanging cabinets and rack from different materials, e. g. from stainless steel or komaxit paint. We can offer door fronts in different colours. Cabinets can be free standing or fixed to the wall, double or single. Cabinet doors can be full or transparent to allow easy insight. They can also be lockable, dust-tight closing or sliding.



Don't you know how to select? We will be happy to advise you! Toll free: +420 800 100 798

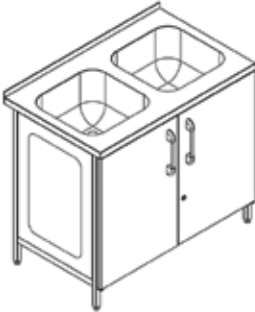
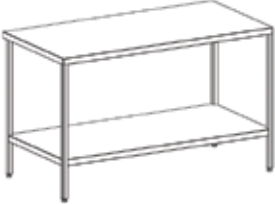

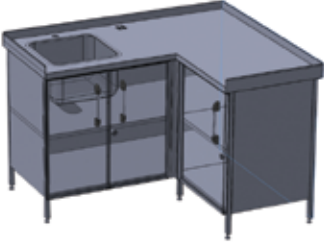
TABLES

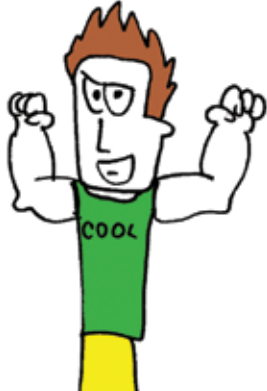
We offer complements to room equipment, such as stainless steel welded or moulded sinks and double sinks, desks in different arrangements, both direct and corner, with shelves, cabinets and doors. Desks may include edges, barriers, cabinets with colour fronts, lockable or dust-tight doors. Everything atypical according to dimensions provided.

<p>Table with two sinks CN 21/17</p> 	<p>Table with sink CN 4/17</p> 	<p>Sink table with doors CN 99/16</p> 	<p>Stainless steel desk CN 106/16</p> 
<p>Sink table with doors CN 173/16</p> 	<p>Stainless steel corner table with sink and shelves CN 207/15</p> 	<p>Stainless steel working desk with drawers and shelves CN 116/17</p> 	

MOBILE CABINETS AND RACK FOR SUs/STE CONTAINERS

Open carts or carts with lockable doors serve for transfer of sterilisation material in SUs/STE containers.

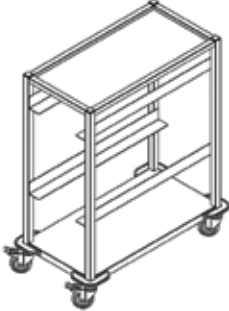
<p>Mobile cabinet for SUs/STE containers CN 88/15</p> 	<p>Stainless steel mobile cabinet for SUs/STE containers CN 109/16</p> 	<p>Mobile sterilisation cart CN 192/15 - VA</p> 	<p>Mobile sterilisation cart CN 192/15 - VB</p> 
-----------------------------------------------------------------------------------------------------------------------------------------------	----------------------------------------------------------------------------------------------------------------------------------------------------------------	------------------------------------------------------------------------------------------------------------------------------------------	-------------------------------------------------------------------------------------------------------------------------------------------

ATYPICAL PRODUCTION

CARTS FOR TRAYS AND TABLETS

For gastro facilities we offer carts of various dimensions for handling and transfer of sheets, trays, meal containers and dining tablets with side handles with spacing according to their type.



INSTRUMENTATION CARTS





Carts built for needs of a specific department with optional equipment. We offer carts made of stainless steel or komaxit paint, with fixed or adjustable shelves, with drawers, panels for connecting instruments, holder of bottles, infusions, endoscopes, hooks, etc.

We will be glad to discuss everything with you, and we will assemble an instrumentation cart according to your needs and requirements.





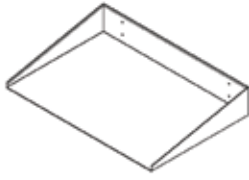
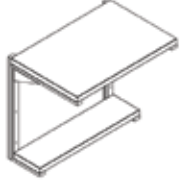



Don't you know how to select? We will be happy to advise you! Toll free: +420 800 100 798

WALL SHELVES AND HOLDERS

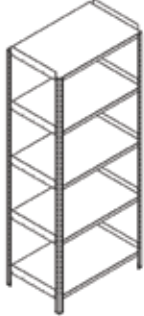
<p>Wall stainless steel shelf CN 9/16</p> 	<p>Wall stainless steel shelf CN 108/15</p> 	<p>Wall stainless steel shelf CN 117/16</p> 	<p>Wall stainless steel shelf CN 118/17</p> 
<p>Wall stainless steel holder of 3 glove packs CN 109/17 - VB</p> 			

RACKS

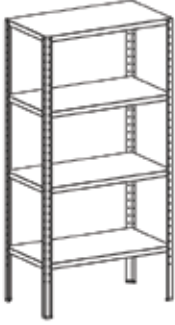
assembled
 adjustable
 welded
 mobile
 fixed
 stainless steel
 komaxit coated
 with cover
 zincd

<p>Mobile adjustable rack CN 15/17 - VA</p> 	<p>Stainless steel assembled rack CN 16/17 - VA</p> 	<p>Welded rack with cabinet CN 65/17 - VA</p> 	<p>Welded rack CN 65/17 - VB</p> 
<p>Welded rack with sides CN 83/16 - VA</p> 	<p>Stainless steel assembled rack CN 137/16</p> 	<p>Stainless steel mobile rack CN 180/16 - VB</p> 	<p>Stainless steel assembled rack CN 181/16</p> 

Don't you know how to select? We will be happy to advise you! Toll free: +420 800 100 798

CONCLUSION

After almost 30 years, we still like to assemble atypical product for all our customers. We are still learning from you, and we are still trying to expand and improve our offer.



We will be glad to specifically atypical the graphic design according to your requirements.

We hope you like our catalogue, although it does not include all what we offer...
Your demanding and responsible work creates continuous motivation for us to keep our products improving.



During the time you were reading the catalogue, we developed something new, but let's talk about it next time...

Now we are looking forward to receiving your next ideas and orders...

Your KLARO team.

Didn't you find what you were looking for?

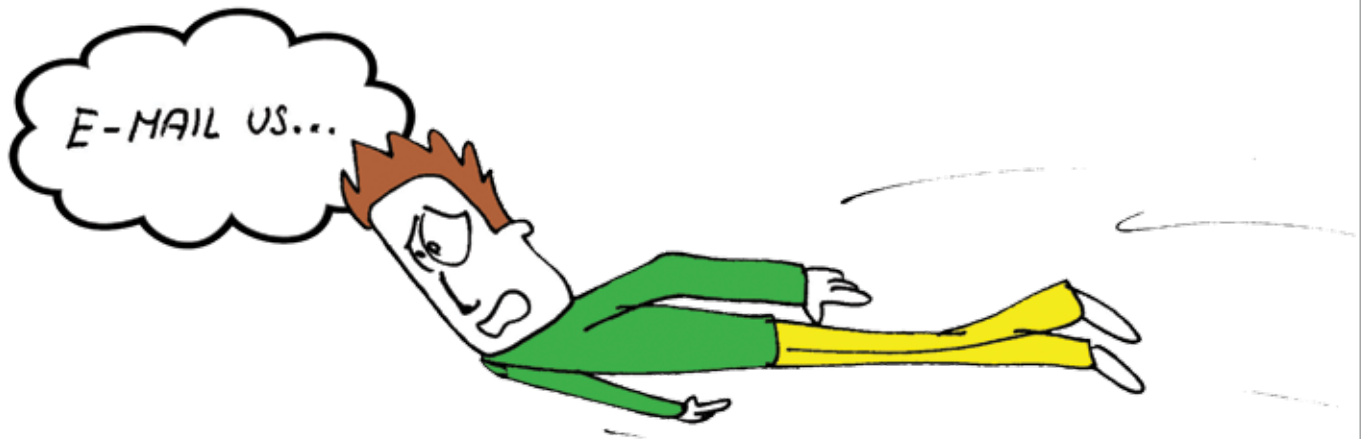

export@klaro.cz

www.klaro.cz



+420 314 005 420, toll free: +420 800 100 798





LET'S BECOME
OUR INSPIRATION...

WILL GUIDE YOU,
WILL ADVISE YOU
AND WILL MAKE
AN APPOINTMENT
FOR YOU...

KLAROBOT
YOUR SELECTION
ADVISOR...



Office address: Klaro, spol. s r. o., Podolska 103/126, 147 00 Praha 4
Czech Republic

Facility address: Klaro, spol. s r. o., Velke Chvalovice 187,
289 11 Pecky, Czech Republic

Phone: +420 314 005 420, **fax:** +420 321 785 819, **e-mail:** export@klaro.cz

ONLINE catalogue is available at our website:

CZECH
MANUFACTURER
WWW.KLARO.CZ